

The 22nd Singapore Robotic Games 2015

21 & 22 JANUARY 2015

RULE BOOK

V 22.0

15 AUGUST 2014

21ST SINGAPORE ROBOTIC GAMES 2014 MAIN COMMITTEE MEMBERS:

<u>Name</u>	<u>Dept, School</u>	<u>Tel</u>	<u>Fax</u>	<u>E-mail</u>
Mr. Keh Chow Toon	NYP	6550-0946	6454-9871	KEH_Chow_Toon@nyp.edu.sg
Mr. Leong Kum Cheong	NYP	6550-0923	6452-0400	LEONG_Kum_Cheong@nyp.edu.sg
Mr. Siew Peng Shorn	NYP			SIEW_Peng_Shorn@nyp.edu.sg
Mr. Yoon Eng Tong	NYP	6550-0997	6454-9871	YOON_Eng_Tong@nyp.edu.sg
Mr. Ruan Zhilong	iNOVA			ruanzl@inovamicro.com
Mr. John Heng Kok Hui	MPE, NTU	6790-5900	6792-4062	mkhheng@ntu.edu.sg
Mr. Chong Chon Hsien	ITE			chong_chon_hsien@ite.edu.sg
Mr. Stephen Chan	ITE			Lai_shui_mun@ite.edu.sg
Mr. Ng Ho Heng	ITE	6772-0030	6872-1943	Ng_Ho_Heng@ite.edu.sg
Mr. Fong Chiew Min	ITE			Fong_Chiew_Min@ite.edu.sg
Mr. Chan Tze Wee	ITE			
Mr. Kwee Tiaw-Joo	NP			ktj@np.edu.sg
Ms. Regina Ng WK	NP			cwk@np.edu.sg
Mr. Hui Tin Fatt	TDC, NP	6460-6190	6463-4745	htf@np.edu.sg
Mr. Ng Nai Fatt	ECE, SP			naifatt@sp.edu.sg
Mr. Teo Chin Heng	SP			teoch@sp.edu.sg
Dr. Pang Kian Tiong	S'pore Sc Ctr	6425-2576	6565-9533	ktpang@science.edu.sg
Mr. Peter Lim Shee Soon	Engrg, TP			limss@tp.edu.sg
Mr. Shi WeiXiong	Engrg, TP			
Mr. Tan Cheng Khoon	Engrg, TP			
Mr. Wong Peng Soon	Engrg, TP			
Mr. Prasanna Kumar	Engrg, RP	6419-6234	6415-1310	Prasanna_kumar@rp.sg
Dr. Marcelo H. Ang Jr.	MPE, NUS	6516-2555	6779-1459	mpeangh@nus.edu.sg
Mr. Yee Choon Seng	SIMTech			csyee@simtech.a-star.edu.sg

SRG Home Page : <http://guppy.mpe.nus.edu.sg/srg>

Rules in the SRG Home Page will be used eventually in the Games.

TABLE OF CONTENTS

1. Open Category	3
2. Legged Robot Marathon Race	5
3. Wall Climbing Robot Race	8
4. RC Sumo Robot Competition	11
5. Pole Balancing Robot Competition	13
6. Autonomous Sumo Robot Competition	19
7. Picomouse Competition	21
8. Robot Colony Competition	27
9. Intelligent Robot Contest	31
10. Robot Soccer Competition	37
11. Schools' Robotic Competition	45
12. RC & Autonomous Underwater Robot Competition	52
13. Humanoid Robot Competition	57
14. Version Notes (V22.0)	60

OPEN CATEGORY

1. OBJECTIVE

The contestants are to demonstrate a robot that performs interesting tasks for applications such as in entertainment, domestic chores, industry etc.

2. BRIEF DESCRIPTION

- 2.1 The competing robots, which can be self-navigating or remote-controlled, will perform their capability on a 5m x 5m contest arena for a period of time.
- 2.2 The robots may move freely around the arena or be in a static position.
- 2.3 Participants are required to submit a video clip or digital photographs (up to a maximum of 2MB in total file size,) of their entry to the organiser when you submit your entry for the qualifying round. See section 4 for details on pre-qualification.

3. RULES AND GUIDELINES

- 3.1 The competing robots can start from any point in the contest arena.
- 3.2 A total duration of up to 10mins is allocated for setting up the robot and any accessory equipment and demonstration of its capability. The time duration will be measured from the moment the contestants enter the arena. If more than 10 minutes elapsed, the robot must be removed from the arena.
- 3.3 In the case where the contestants wish to employ radio control, they should inform the secretariat in advance. Contestants should not broadcast radio signals while another contestant's robot is performing.
- 3.4 In the case that a robot requires special accessory equipment or tools during its performance, the contestants will provide such items.
- 3.5 In the case that a robot performance is to be accompanied by music, the contestants should provide the means to reproduce this music.
- 3.6 There is no specific flooring material of the contest arena. The flooring will very much depend on the available contest site. However, if there is a special requirement such as carpet, the contestants will have to provide for it.
- 3.7 One power point of 220/230V, 50 Hz supply will be made available. However, the teams are to provide their own power adapter and extension means if it is required.
- 3.8 For air supply, the contestants are to provide their own air compressor units if necessary.
- 3.9 The designs of the competing robots must be original and unique. No two identical designs are allowed in the competition.
- 3.10 The expenses incurred in transportation and setup of equipment is to be borne by the individual teams.
- 3.11 The boundary for the area will be black or white depending on the floor.
- 3.12 Winning robots will not be allowed to participate in the subsequent two Robotics Games.
- 3.13 Robots that can, in principle, compete in other SRG events (e.g. Pole Balancing Robot competition) should not be allowed to compete in the open category event.

4. PRE-QUALIFICATION

- 4.1 During the preliminary round, participants are required to submit a video clip (max 2 Mb), readable in standard MS Windows Media Player, of up to 2 minutes, or digital photos of their robot in performance sequence, (Max 2 MB in total) of their robot, by the closing date. (Refer to <http://guppy.mpe.nus.edu.sg/srg/> for information.)
- 4.2 A panel will evaluate the entries based on the video clips submitted.
- 4.3 Results of the preliminary round will be announced on the web site 1 week before the competition.
- 4.4 Only qualified participants will be permitted to present their robots for the final round.

5. JUDGING CRITERIA

Degree of Innovation	20%
Design & Realisation	20%
Performance	30%
Content	30%
- Entertainment (e.g., audience participation)	
- Applications	

6. EXHIBITION

- 6.1 All entries will be allocated exhibition space where the robots will remain throughout the day. Contestants are to man the exhibits at all times and should be available to answer questions from judges and members of the public.
- 6.2 Prize winners will only be announced at the end of the day of the competition.
- 6.3 Judges decision is final.

LEGGED ROBOT MARATHON RACE

1. OBJECTIVE

To design a Legged Robot to travel on a designated track by either walking, running or hopping on a flat terrain for a total distance of approximately 28.9 x 6 metres.

2. SPECIFICATIONS OF ROBOT

- 2.1 The robot must have at least one leg. There is no limit to maximum number of legs used. The maximum length and maximum width of the robot is restricted to a 0.6m x 0.6m square area in the starting zone. There is no height restriction on the robot. There is no restriction on the dimension and geometry of the robot once it started each race attempt (ie: once any part of the robot crosses the starting line.)
- 2.2 The robots must be completely autonomous. It should contain both the controller and power units. The robot must not weigh more than 10 kg. In addition, the power unit attached to the robot must not exceed 1 kg. Spare power units must be identical.
- 2.3 Radio-frequency (RF) control is strictly prohibited in the robot design except for start/stop operation of the robot (i.e., remote push button to start and stop the operation of the robot.)
- 2.4 Each leg of the robot must consist of minimum two limb segments and demonstrate relative motion between the limbs to realise a walking motion.
- 2.5 The limbs of the robot must include some means of controlled motion to realise the walking, running, and/or hopping action for the robot. The following are some examples NOT considered as a legged robot:
 - Rotating wheel with spokes or any other structure sticking out radially to represent 'feet'.
 - Traction belt with studs or roller chain with 'feet' mounted in any orientation.
 - Robot, with feet or any floor contact point, mounted with motion-assisted roller wheel(s) is strictly prohibited
- 2.6 Locus for every feet of the robot cannot be higher than its associated pivoting joint.

3. SPECIFICATIONS OF RACE TRACK

- 3.1 The race-track is a raised platform of a fixed width of approximately 0.6m wide and is approximately 28.86m in length (1 lap.)
- 3.2 The track comprises of straight and circular segments connected together. Each circular segment consists of a circle quadrant of radius (with reference to the retro-reflective tape) 0.5m or 1.5m. The entire track is constructed with 1/4-inch plywood with circular and/or straight segments raised about 50 mm off the ground (if 50 mm track is not available, the entire track will use 100 mm height). The top surface will be painted in mat black. It is designed to support a robot with a maximum weight of 10 kg. The joint between 2 track segments is **NOT** expected to be perfectly level and it may be uneven. Track segments at the same elevation are joined with a maximum step at the joints of 5 millimetres. There is a 50 millimetres wide retro-reflective tape (3M Scotchlite - Industrial Grade) in the middle of each path for navigation purpose.

Fig.1 shows the top view of a sample competition race-track. The actual competition track which consists of 28 curve segments and 10 straight sections. The starting position and orientation will be determined by the judges in a random manner.

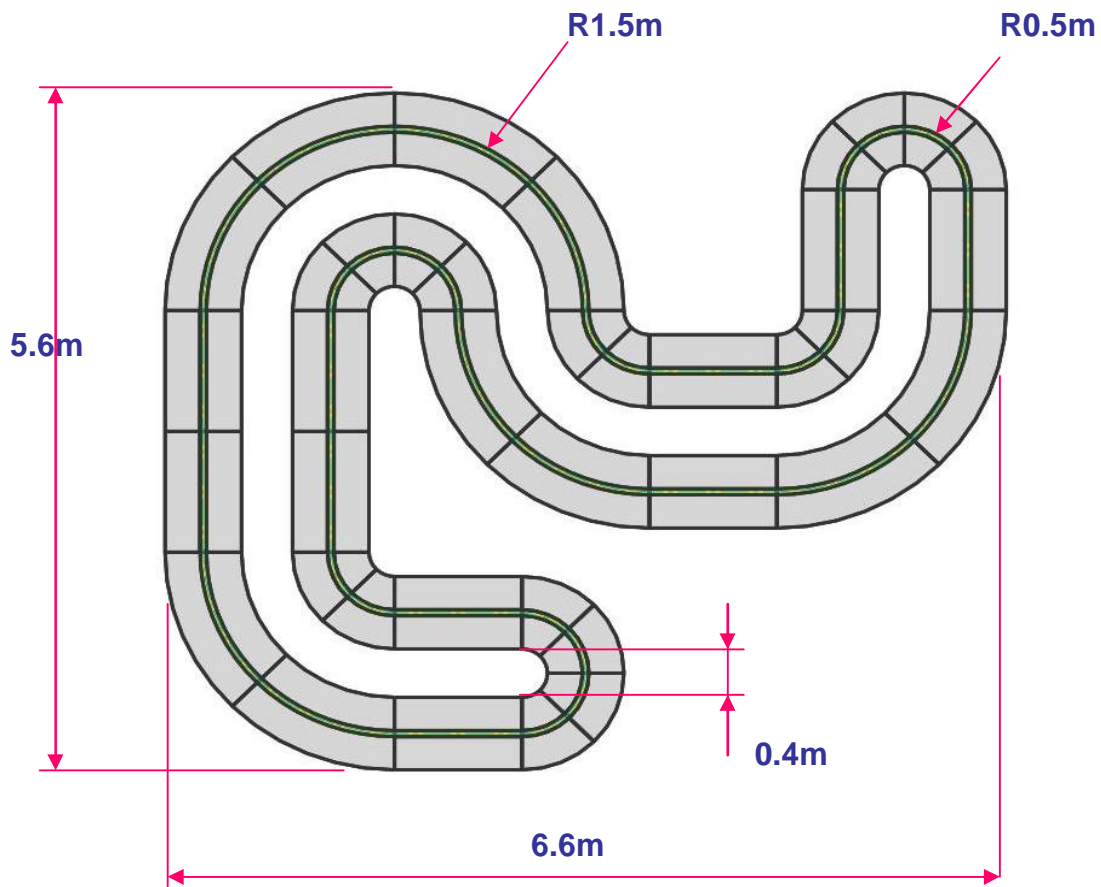

Fig. 1 The Legged Robot Race Track

4. FORMAT OF COMPETITION

- 4.1 Each robot is to run 6 laps around the closed track. The starting position for the robot will be made known at the beginning of the competition. The time taken to complete 6 laps will be recorded.
- 4.2 Each team will be given 5 minutes to complete at least two 6-lap runs in opposing direction, i.e. one in clock-wise and the other in anti-clock-wise direction. The robot must complete at least 1 6-lap run and register a valid running time to qualify for a prize.
- 4.3 The robots with the fastest running time will be declared the winning entries, subject to the general competition prize guidelines.

5. RULES OF COMPETITION

- 5.1 Robot will be “caged” at least 30 minutes before the start of the competition. Once the competition starts, no individual is allowed to access the robots in the “caging” area.
- 5.2 The sequence of robot runs will be determined by drawing of lots. The robot has to complete the entire competition race-track for each race. No change of batteries is allowed during the competition. No cleaning of robot parts and tracks are allowed.

- 5.3 Robot is to start from a stationary starting position, with the extremity of the robot aligned to the start line. It has to travel along the track either by walking, running or hopping, or any other motion not identified as wheeled motion.
- 5.4 Robot must keep within the designated track during the race. The result is void if
- any part of the robot completely touches the ground or the robot falls off the track before fully crosses the Finishing line. Or
 - any part of the robot crosses to the other track.
- If any of the above situations occurs, the participant, under instruction from the judge, must remove their robot immediately.
- 5.5 The race and race time both starts by the blow of a whistle. A valid **Recorded Time** is measured from the time then the whistle is blown until the moment when any part of the robot crosses the Start/End line at the Start Zone after 6 laps. Any robot moved before the whistle is blown will be considered a **False Start**. All robots shall only be given 1 False Start warning and subsequent False Start will imply the robot has lost a race.
- 5.6 No parts of the robot are to be left behind on the race-track. Winning is based on the best time of a completed race for each robot. If the robot failed to achieve any single complete run, it shall be retired from the competition.
- 5.7 During the competition, If the robot, under any circumstance, does not demonstrates any positive action to start or complete the race (eg: always crash or run out of track for no apparent reason) may be asked to retire by the discretion of the judges.
- 5.8 Once the robot has started its race, the robot handler can only access the robot after it crosses the Finishing Line or the robot runs out of the track completely.
- 5.9 Modification of robot during competition is **STRICTLY PROHIBITED**. No extra parts are to be added to or removed from the robot once the competition time starts.
- 5.10 All robots should be returned to the caging area or a designated location after its run. The teams are not allowed to take back their robots before the whole competition is concluded.
- 5.11 Any violation of the rules above would result in the run being invalidated.

6. CLONING

- 6.1 Clones will only be awarded one prize. Clones will be identified during the "caging" procedure.
- 6.2 Clones are robots with substantially identical physical appearance and walking mechanism. Scaling of the same mechanism is considered as cloning.
- 6.3 When in doubt, the decision of the Judges will be final.

WALL CLIMBING ROBOT RACE

1. OBJECTIVE

The aim of this event is for mobile robots to demonstrate their horizontal and vertical surface climbing abilities during a race.

2. THE COMPETITION ENVIRONMENT

2.1 The wall is shown in Figure 1. It consists of three sections: a two metres long horizontal section (section A) on the ground followed by a two metres high vertical section (section B) followed by a two metres long horizontal section (section C) at the top, with each section at least 0.8 metre wide. The following tolerance will be applied:

- (a) length of each wall section should be $2000 \text{ mm} \pm 5 \text{ mm}$.
- (b) angle formed between two adjacent wall sections should be $90^\circ \pm 0.5^\circ$.

The wall will be deemed to have satisfied criteria (a) and (b) above and be considered fit for use if each of the two distances between diagonally opposite corners (using the side view in Figure 1) lies in the range 2733 mm to 2847 mm.

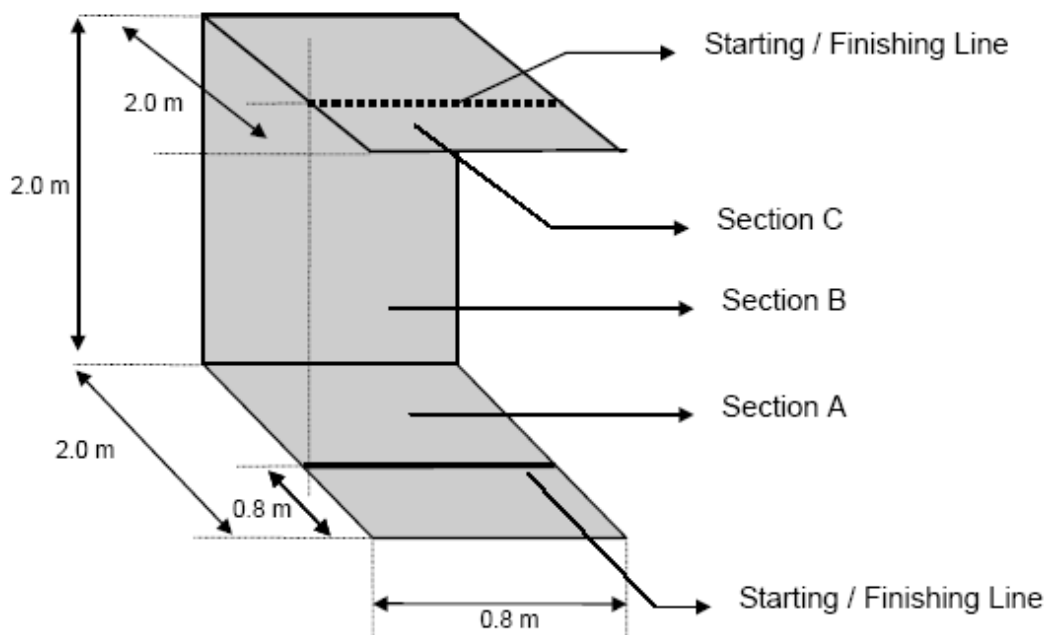

Figure 1: The wall for the wall-climbing robot race

- 2.2 The vertical wall section (Section B) will be covered with a transparent Polycarbonate sheet with thickness ranging between 10 to 15 mm. The 2 horizontal top (Section C) and bottom (Section A) walls will be covered with metal sheets having matt black surface finish.
- 2.3 Starting / finishing white lines will be located 0.8 metre from the edge of the horizontal section (section A and C.)
- 2.4 The supporting structure for the wall will have provision for two safety cables to be attached to the robot so that both cables can be used simultaneously during the race (not shown in Figure 1.)

3. THE COMPETITION

3.1 Robots will start from a stationary position with the front-most part of the robot lying behind the starting line in section A as view vertically from above. (see Figure 2.)

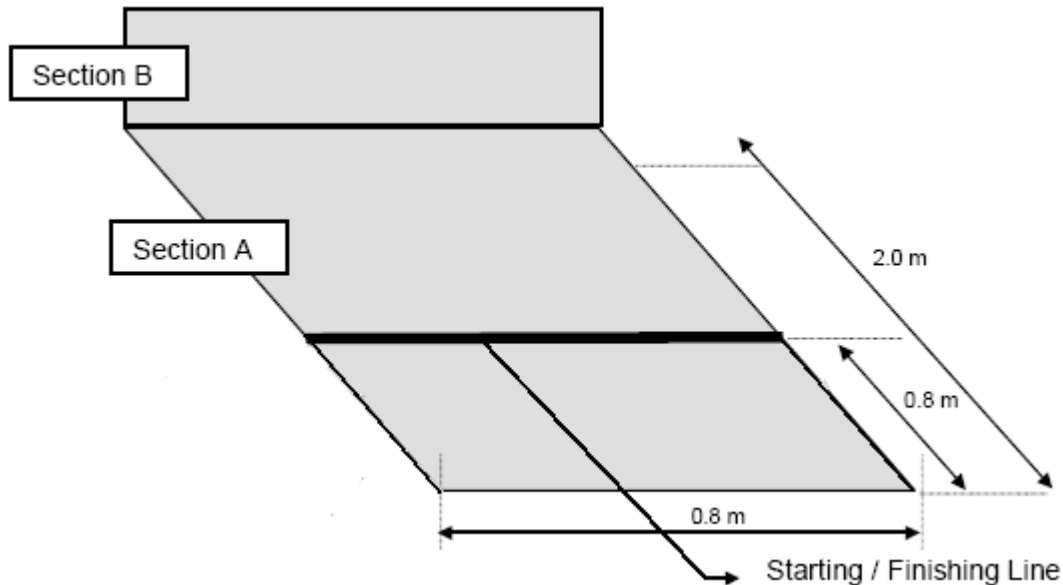

Figure 2: The starting line for the wall-climbing robot race viewed from above wall-section A

3.2 On reaching the vertical section (section B) the robots shall climb up the vertical section and subsequently climb 'upside-down' to the end of the top horizontal section (section C.)

When the trailing end of the robot crosses the finishing line, the robot shall climb back through sections C, B and A in sequence. The sequence of wall sections to be climbed from start to finish is A-B-C-C-B-A.

3.3 If applicable, each robot will have a penalty time of **6 seconds** added to the shortest time that it is able to complete its climb through the entire sequence of wall sections according to paragraph 3.2. The criterion to determine if a penalty is applicable is when the robot makes use of magnets in order to climb any wall sections.

3.4 The robot that completes the entire sequence of wall sections according to paragraph 3.2 qualifies itself for a prize. The robot that qualifies with the shortest time and in accordance with all the rules wins.

3.5 All robots are to be fully autonomous and self contained with their own power supply, control and intelligence built-in within the robot itself.

3.6 No human interference is allowed after the cage-in and during the run.

3.7 During each run, a robot is deemed to have started once any part of the robot crosses the starting line in the wall section A.

3.8 A robot is deemed to have completed its climb through a particular wall section when it fulfils all of the following conditions (a), (b) and (c) in sequence:

- (a) robot touches the wall section that it is about to complete;
- (b) robot simultaneously touches both the wall section that it is about to complete as well as the next wall section in the sequence of wall sections that is consistent with its direction of travel; and

- (c) robot ceases to touch the particular wall section that it is about to complete and touches the next wall section in the sequence that is consistent with its intended direction of travel.

The above conditions apply to all wall sections except in the following cases:

- (i) when the robot completes its climb through the wall section C for the first time in the sequence according to paragraph 3.2; and
- (ii) when the robot completes the last wall section (wall section A) in the sequence according to paragraph 3.2.

In both cases (i) and (ii), the robot is deemed to have completed its climb through the wall section only when the entire robot has crossed the finishing line placed within that particular wall section.

- 3.9 Each team shall be given a maximum of **10** minutes to produce its best result once the robot is removed from the caging area.
- 3.10 After the race begins, any physical handling of the robot such as touching, pulling of cables or pushing of the robot during a climb will disqualify the result of that climb. However if a robot falls off while climbing the wall, using the safety cables to break the fall of the robot is allowed and the result of the climb will be determined as specified in paragraph 3.3 & 3.4.

4. THE ROBOTS

- 4.1 The dimensions of each of the competing robots must not exceed 0.75 metre in length and height, and 0.6 metre in width at all times while the robot is in operation.
- 4.2 The weight of each of the competing robots must not exceed 10 kilograms.
- 4.3 Competing robots must not have parts removed or added to them during the competition except for replacement of batteries or for repairs essential to the operation of the robot. The competing robots are not allowed to discard any part of their chassis during operation. The competing robots must not use chemical or combustion power methods.
- 4.4 The competing robots must not damage the competition environment including the wall and its supporting structure and the sensors in any way.
- 4.5 The competing robots must not endanger the judges and the spectators in any way. All competing robots must be firmly secured with two safety cables at all times during operation.
- 4.6 A robot will be disqualified during the competition if it endangers the judges, the participants or the spectators in any way during the competition, or if it damages the competition environment. Alternatively a robot may be banned from competing if, in the opinion of the judges, it is likely to pose a safety hazard or cause damage to the competition environment.

5. CLONING

- 5.1 In accordance with the spirit of the competition, clones among the winning entries will only be awarded one prize. Clones will be identified during the "caging" procedure.
- 5.2 Clones will be identified by the working principles of the whole robotic system, such as the sequence of operations and negotiating the wall bends.
- 5.3 When in doubt, the decision of the Judges will be final.

RC SUMO ROBOT COMPETITION

1. OBJECTIVE

Participants are required to build a self-contained mobile robot that is able to push its opponent out of the specified ring in according to the tournament rules. Robot handlers are to operate their robots through the radio-controlled console.

2. ROBOT SPECIFICATIONS

2.1 Dimensions and Weight

The size of the robots shall not exceed 20cm (length) x 20cm (width). There is no height restriction and it may take any shape and size once the match begins.

The weight shall not exceed 3 kg excluding the radio-controlled console used by the robot handler.

2.2 Don'ts in the Design

- 2.2.1 Do not disturb the opponent's radio-control by putting a jamming device in the robot.
- 2.2.2 Robots shall not damage the arena deliberately.
- 2.2.3 Robots shall not throw liquid or powder or other substances at the opponent.
- 2.2.4 Robots shall not employ any flammable devices as a weapon.
- 2.2.5 Robots should not secure itself on the ring surface by using, suction cups, diaphragms, sticky treads, glue or other such devices.
- 2.2.6 Projectile weapons or saw-blades are prohibited.

2.3 Radio-controlled Frequencies

- 2.3.1 The radio-controlled frequencies shall only be FM 27 MHz or 2.4GHz Digital Spectrum Modulation (DSM).
- 2.3.2 Participants who are using FM 27MHz must be capable of operating in any of its frequency bands. Participants are allowed up to two changes in frequency bands in a game. If the robot failed to proceed after the second band change, it shall be retired from the game.

2.4 Labelling

All robots must be labeled with of their team names on the front of the robot. The minimum font size is Arial 24.

2.5 Clearing of Debris

Fallen items from the robots shall be removed after each match.

3. RING SPECIFICATIONS (REFER TO FIGURE 1)

3.1 Dimensions and Materials

The ring arena is made of a single ½" MDF board and covered by a 3mm black hard rubber sheet. The diameter of the ring is 154cm including the boundary marking.

3.2 Markings

Two red-brown color starting lines (20cm x 2cm) locate at 20cm apart at the centre of the ring. They indicate the starting positions for two competing robots.

The boundary of the ring arena is marked in white color. The width is 5cm.

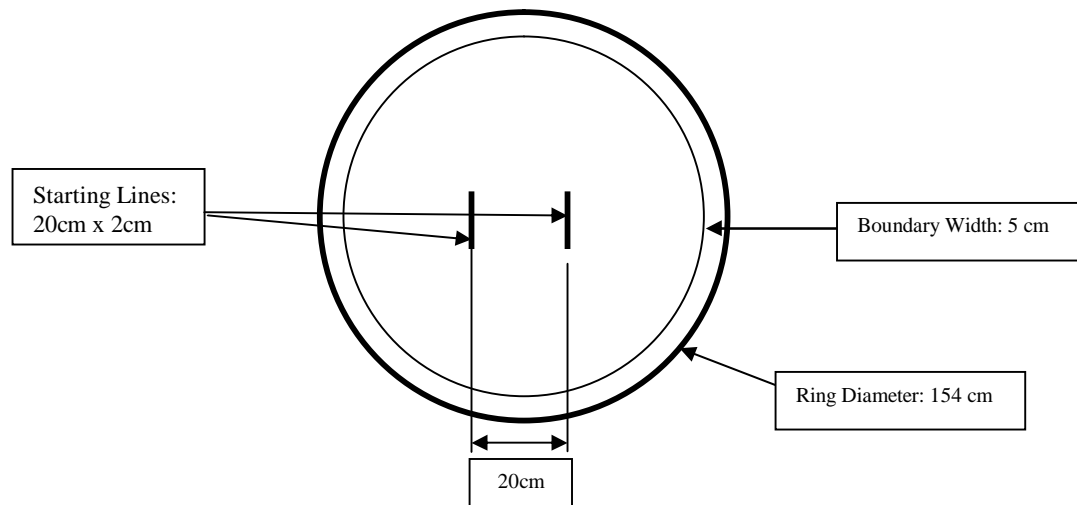

4. GAMES RULES

4.1 Sumo Game

The tournament shall divide the participating teams into groups of maximum 4 robots.

A game consists of 3 matches. Each match shall last for 2 minutes. One point shall be given to every match winner. Zero point shall be given to a draw or a loser.

If a game ends with no winner, a test of strength by the two robots immediately after the last match will be the decider.

4.2 Match Winner

A robot wins when any part of the opponent robot touches the floor.

4.3 Service Time

Participants will be given one minute of Servicing -Time before the start of their game. A maximum of two members are allowed to service their robots at a designated area under supervision. Only replacement of identical parts and batteries are allowed during the Servicing-Time.

4.4 Time Out

Each team will only be given one time-out of one minute within a game (of 3 matches). The time-out will apply after the match and only for the requesting team. Changing of battery is not allowed during the time-out.

4.5 Robot Handler

A participant is allowed to handle only one same robot throughout the event. Each robot should only have one same handler. The handler and robot will be identified during registration and caging.

5. CAGING

Robots shall be inspected and caged at least 1 hour before the start of the game.

POLE BALANCING ROBOT

1. INTRODUCTION:

The competition is among the robots, which support an inverted pendulum that is free to swing around a point with two degrees of freedom, and balance it to keep it vertical by moving the point of support along a horizontal plane.

2. ACCEPTABLE VERSIONS:

- 2.1 The inverted pendulum may be supported by a vehicle moving along a horizontal plane in order to keep the pole vertical. Any other innovative design, which does not violate the spirit of the competition, may be allowed at the discretion of the judges.
- 2.2 There is no size restriction on the robot. The overall size will be such that it would be able to operate on the table provided by the organisers. No part of the robot, other than its driving wheels, steering wheels, or encoder wheels, must touch the surface of balance table. It must not fall off the competition table surface during the operation.
- 2.3 Balancing the pendulum/pole using any form of gyroscopic principle, counter weight, or non-linear friction is not admissible.
- 2.4 The pole support mechanism and measurement devices should in no way restrict or hold the pole at any time.
- 2.5 The vehicle must be *completely* autonomous, with no wires connected externally and with no RF signals or power lines coming from outside.
- 2.6 There should be no relative motion between the pole-support *system* and the body of the vehicle.

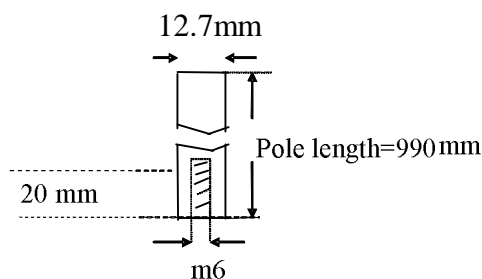

Fig.1. Pole Dimensions

3. POLE-SUPPORT MECHANISM AND OVERALL SIZE:

- 3.1. The pole is shown in Fig.1. The pole should have the dimension shown in Fig.1, with the length of 990 mm and outer diameter of 12.7 mm with a tolerance of 5%. The pole must have uniform cross section and weigh **150** grams with in a tolerance of 5 %. When the pole is placed with its centre on the middle of a support surface of 1.5 cm width, with both sides overhanging, the pole should not topple. A few such poles will be collected from participants and the competition pole will be picked arbitrarily from the lot by the judge.
- 3.2 The pole will be supplied by the main committee.
- 3.3 Due to the complex nature of pole angle measurement, the participants are allowed to use their own pole support and measurement subsystems, at this point in time.

4. FRICTION TEST:

In order to uphold the integrity of the game, the pole support should offer minimum friction to the swinging pole in all directions.

- 4.1. Test: The friction of the suspension mechanism is quantified as follows: The pole used for balancing is also used for this purpose. The robot will be placed upside-down to make the pole a regular pendulum.

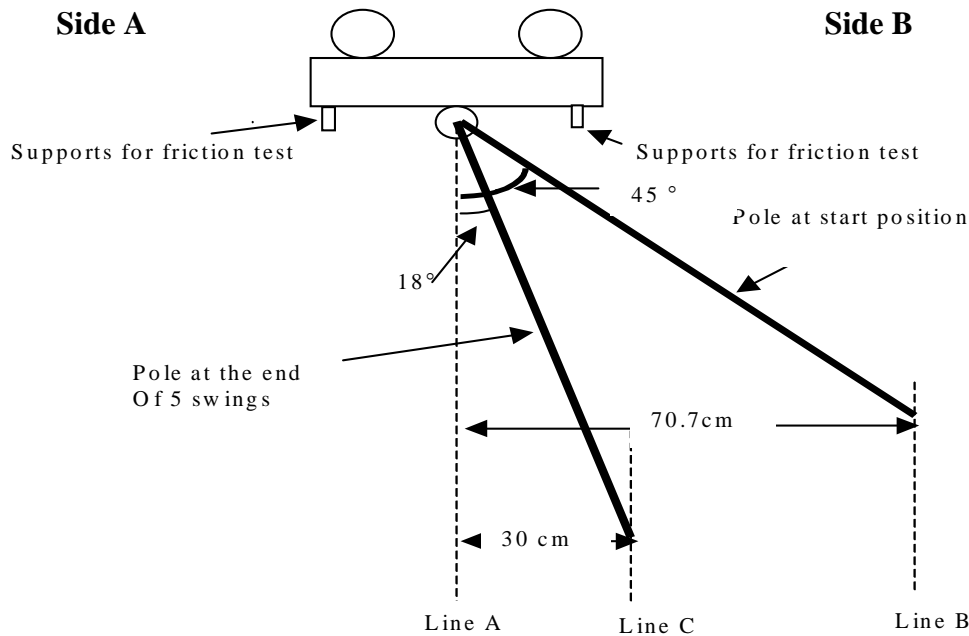

Fig.2 Friction Test Procedure with inverted Robot

For the test, the robot is supported upside down such that the pole support axle is along the vertical line A, marked on the wall or the platform built for this purpose. There will be two vertical lines on the right side. One (extreme right line B) corresponds to 45° inclination of the pole. The second inner line C corresponds to 18° inclination of the pole, at a distance of 30 cm from line A.

The pole will be moved to side A to reach an inclination of 45° such that the tip touches the outer vertical line B and is released, so that it swings back and forth. At the end of the fifth swing cycle the pole should swing back to side A and reach a minimum angle of 18° such that the tip touches the inner vertical line C.

- 4.2 The test in section 4.1 will be repeated after turning the robot 90 degrees around the vertical axis and placing it on the same support.
- 4.3 The judges may also perform the same test at any intermediate angles to satisfy themselves that the pole has two degrees of freedom. In short, the pole should be able to move along a cone surface with the pole support as the vertex, while suffering minimum friction.
- 4.4. The organizers strongly recommend that the robots have projected supports perpendicular to the base plate at the front and back of the robot, to facilitate easy placement during friction test. See Fig. 3a. The dimensions of the support provided on the robot must be such that the inverted robot can be placed on the friction test structure shown in Fig.3.

4.5. In order to further reinforce the integrity of the game, handlers of each winning robot might be asked to open up the pole support mechanism and pole angle measurement system for inspection by the judges, explain the use of each part in those systems, and answer any query that may arise.

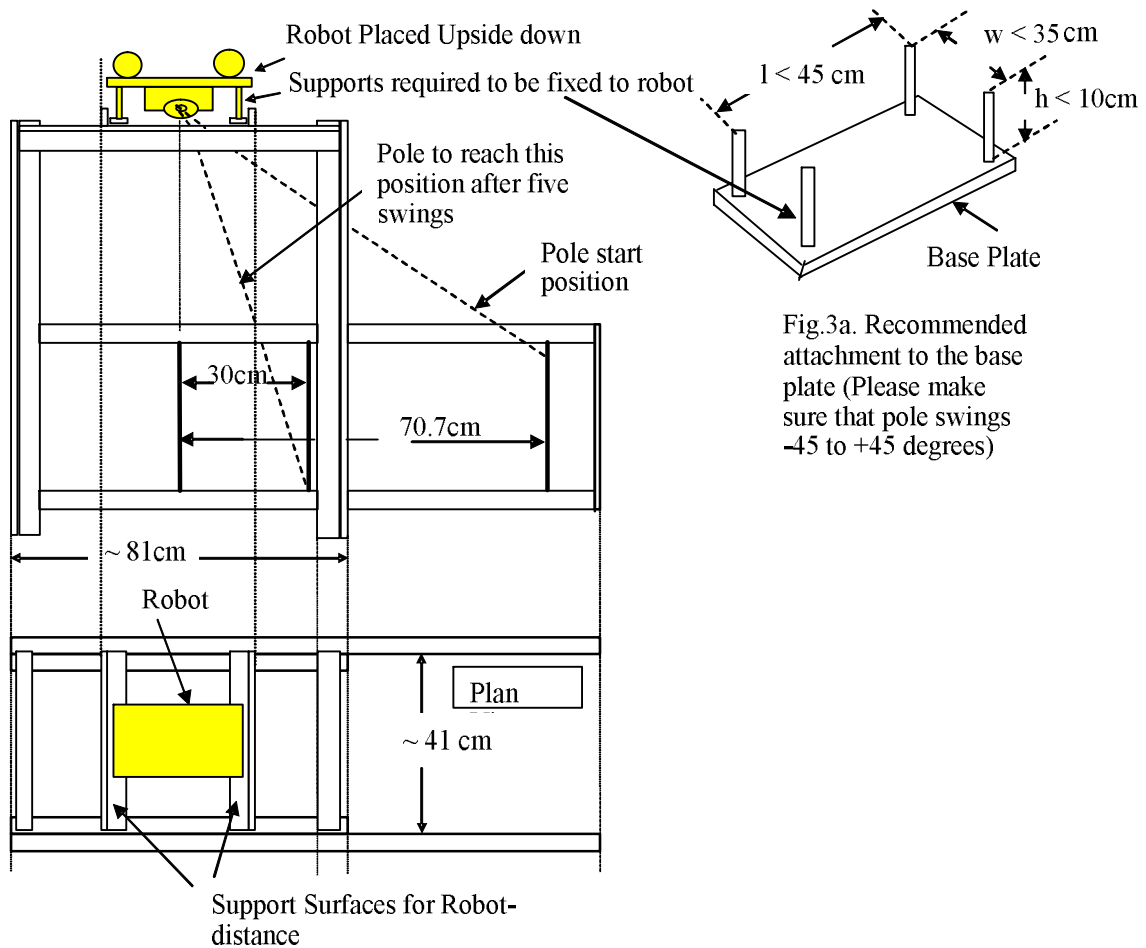

Fig.3a. Recommended attachment to the base plate (Please make sure that pole swings -45 to +45 degrees)

Fig.3. Friction Test Structure

5. COMPETITION PLATFORM:

5.1 The competition table is shown in Fig.4. One common competition table will be used by all competitors. The competition platform consists of a horizontal wooden surface with a dimension of 3 m x 1.5 m. A rubber mat of 1.3 mm thickness will be used on the top of the table to improve the grip of the wheels. Referring to the Fig.4, all double lines shown are retro-reflective tapes. S1 and S2 are separators of dimensions 10cm wide, 1cm thick, and 15 cm tall firmly fitted to the competition table. There are five regions of the competition platform namely A1, A2, B1, B2, and C as shown in Fig.4. Regions A1 and A2 symmetrically divide the platform to the left of the line X1-X2 into two equal parts. Similarly regions B1 and B2 divide the platform equally between lines X1-X2 and Y1-Y2. Region C is the part of the platform to the right of line Y1-Y2. Region C is the crossover area, in which the robot is allowed to go from one side to the other. The two guide-tapes extend into region C for 25 cm. Then, tape forms a semicircle linking the two sides. The centre of the semicircle is on the unmarked middle line of the platform and 25 cm away from the Y1-Y2 line. All dimensions ending on tapes are measured from the centre-lines of the tapes. All dimensions will be within a tolerance of 2%.

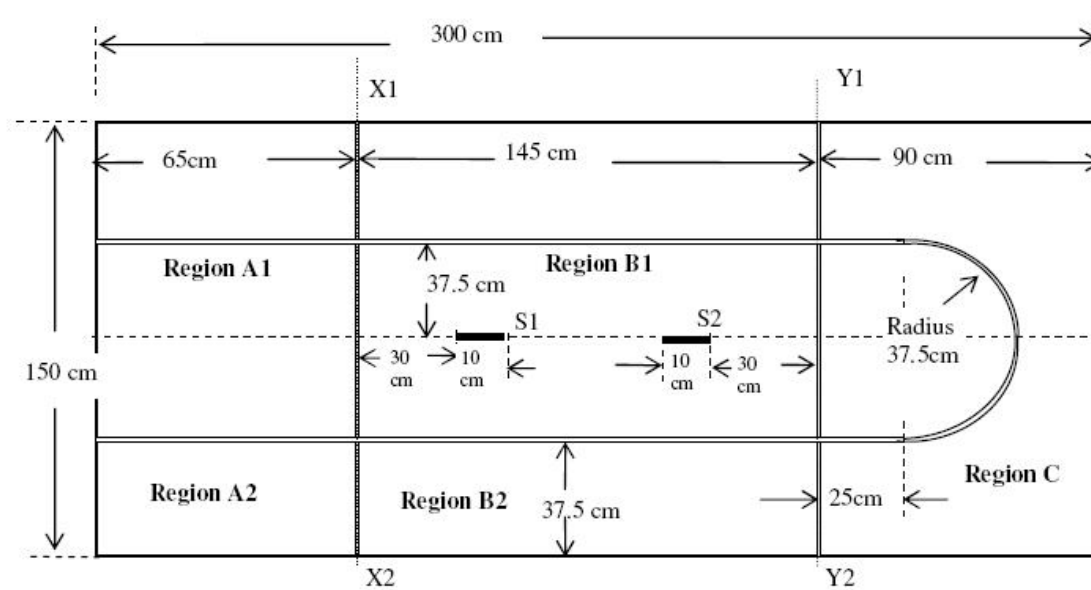

Fig.4. Pole Balancing Robot Platform

6. COMPETITION:

- 6.1 The robotic vehicle would operate on the top of the platform provided. Please see Fig. 4.
- 6.2 The robot may start the race from region A1 or region A2. Likewise, it can complete the race in region A1 or region A2.
- 6.3 If the robot is to start from region A1, the vehicle will be placed within the region A1. The handler may move the pole (the inverted pendulum) to the upright position and release it upon receiving the signal from the judges. The vehicle must balance the pole in the upright position for a minimum duration of 10 seconds without the pole-support base of the robot crossing the line X1-X2 or moving beyond the centre line.
- 6.4 Upon completion of the above task (in 6.3 above), the vehicle should move across the line X1-X2 once, and move through the region B1 until the pole-support clears the line Y1-Y2 at least once and reach region C, without losing balance during transit, i.e. without the pole hitting any part of the table or its own chassis.
- 6.5 Upon completion of the above task (in 6.4 above), the vehicle must cross over to the other side of region C without losing balance of the pole. In this process it may or may not turn. It need not follow any specific path, except it should stay on the platform to the right of S2. Effectively, the robot can travel along the Y1-Y2 line or the semicircle, or any path in between.
- 6.6 Upon completion of the above task (in 6.4 above), the robot should travel through region B2 and move to region A2 until the pole support crosses line X1-X2. This will be counted as one cycle.
- 6.7 The robot may move similarly to retrace the path back from A2 through B2, C, B1, and A1. This will be counted as the second cycle and so on.
- 6.8 The vehicle should repeat such cycles.
- 6.9 The robot may end the run at either region A1 or region A2.
- 6.10 To count these cycles as successful cycles they must be followed by at least 10 seconds of static balancing at the region A1 or region A2 where it ends the run.
- 6.11 The robot may continue on **untouched** for more cycles, and *complete* them with 10 seconds of static balancing at the end, which if successful will be counted cumulatively within a total of 5 minutes of performance time.

- 6.12 If a robot is touched by the handler during the trial, it must be restarted for the next **attempt**. Attempts are scored separately. Scores of separate attempts will not be added, only the best score will be taken. Only robots with valid scores of more than 1 qualify to win a prize.
- 6.13 No robot will be allowed a restart after 5 minutes of performance time has elapsed.
- 6.14 Robot may touch the separators S1 and S2 while travelling, but should not displace them.
- 6.15 Robot's pole support should not cross from B1 to B2 or vice-versa using the space between S1 and S2.
- 6.16 Likewise robot's pole support should not cross from A1 to A2 or vice versa.

7. TIME ALLOWED FOR EACH ROBOT

- 7.1 From the instant the team is called upon to take the arena, 2 minutes will be allowed for set up.
- 7.2 After the set up time, 5 minutes of *performance time* will be allowed for each robot. The *performance time* will start when the participant first releases the robot-pole. However if the set up time exceeds 2 minutes, then *performance time* will start automatically.
- 7.3 Within the time permitted, any number of attempts will be allowed. All the attempts must be *completed* within 5 minutes.
- 7.4 The participants must vacate the competition area when the 5 minutes of *performance time* expires, unless the robot is continuing the current attempt. However, the robot will be stopped after 7 minutes.

8. SCORING:

$$\text{Final score} = A \times B \times C$$

where A = 0 if the robot fails initial static balancing

A = 1 if the robot completes initial static balancing

B = number of cycles achieved during run time from start to 5 minutes, irrespective of how long the robot runs

C = 3.0, if the robot successfully completes 10 seconds of "the final static balancing" within the 5 minutes of performance time.

C = 1.5, if the robot starts "the final static balancing" within the 5 minutes of performance time, but the 10 seconds of "the final static balancing" extends beyond the performance time.

C = 1.2, if the robot continues to run beyond 5 minutes without commencing the final static balancing, but completes it with final balancing within 7 minutes. However the B-count will be limited to the number of cycles achieved within 5 minutes only.

C = 1.0, if the robot pole falls before the 10 seconds of "the final static balancing" is completed or if the pole falls during the run (within 5 minutes limit) when the robot is in any one of the finish areas (A1 or A2)

C = 0.7, if the pole falls during the run (within 5 minutes limit) when the robot is outside both of the finish areas.

C = 0.5, if the robot continues to run beyond 5 minutes, starts final balancing and pole falls during static balancing or does not complete it within 7 minutes. B-count will be limited to the number of cycles achieved within 5 minutes only.

C=0.3, if the robot continues to run beyond 7 minutes, robot will be stopped and the B-count is limited to the cycles achieved during 5 minutes.
C=0.0, for all other cases.

Note: Referring to the scenario described in 6.11, where the robot continues the cycles **untouched** after duly completing the final balancing, in order to improve the score, it may achieve more cycles. In such cases, the additional B-cycles achieved within 5 minutes, will be weighted with appropriate C value(s).

9. CLONING:

- 9.1 In accordance with the spirit of the competition, clones among the winning entries will only be awarded one prize. Clones will be identified during the "caging" procedure.
- 9.2 Clones are robots with substantially identical physical appearance and working principles.
- 9.3 When in doubt, the decision of the Judges will be final.

10. RUBBER MAT USED:

10.1 Brand / Manufacturer & type : Trelleborg SBR 1.5mm - 1.5m:

10.2 Vendor

Khong Lieng Trading Co (Pte) Ltd ,
No. 16 KIAN TECK DRIVE ,
Singapore , 628833 .
Tel : 67478555 ,
Fac : 67467307
Contact person : Eri

AUTONOMOUS SUMO ROBOT COMPETITION

1. OBJECTIVE

Participants are required to build an **autonomous**, self-contained mobile robot that is able to push its opponent out of the specified ring according to the tournament rules. Robot handlers are to start the robot with the press of a single button.

2. ROBOT SPECIFICATIONS

2.1 Dimensions and Weight

The size of the robots shall not exceed 20cm (length) x 20cm (width). There is no height restriction and it may take any shape and size once the match begins.

The weight of the robot shall not exceed 3 kg.

2.2 Restrictions on robot Design

2.2.1 The robot must not have a device that interferes with the sensor operation of its opponent. e.g. Jammer, strobe light, laser & etc.

2.2.2 Robots shall not damage the arena deliberately.

2.2.3 Robots shall not throw liquid or powder or other substances at the opponent.

2.2.4 Robots shall not employ any flammable devices as a weapon.

2.2.5 Robots should not secure itself on the ring surface by using, suction cups, diaphragms, sticky treads, glue or other such devices.

2.2.6 Projectile weapons or saw-blades are prohibited.

2.3 Robot Control

The robot shall be autonomous. No external form of control or any external intervention is allowed. The Robot is to be started with a single Toggle-type switch.

2.4 Labelling

All robots must be labeled with their team names on the front of the robot. The minimum font size is Arial 24.

2.5 Clearing of Debris

Fallen items from the robots shall be removed after each match.

3. RING SPECIFICATIONS (REFER TO FIGURE 1)

3.1 Dimensions and Materials

The ring arena is made of a single ½" MDF board and covered by a 3mm black hard rubber sheet. The diameter of the ring is 154cm including the boundary marking.

3.2 Markings

Two red-brown color starting lines (20cm x 2cm) locate at 20cm apart at the centre. They indicate the starting positions for two competing robots.

The boundary of the ring arena is marked in white color. The width is 5cm.

3.3 Ring Condition

The ring condition may vary slightly and participants should design and build their robots with robustness in mind.

4. GAMES RULES

4.1 Sumo Game

The tournament shall divide the participating teams into groups of maximum 4 robots.

A game consists of 3 matches. Each match shall last for 2 minutes. One point shall be given to every match winner. Zero point shall be given to a draw or a loser.

If a game ends with no winner, a test of strength by the two robots immediately after the last match will be the decider.

4.2 Match Winner

A robot wins when any part of the opponent robot touches the floor.

4.3 Service Time

Participants will be given 1 minute of Servicing-Time before the start of their game. A maximum of two members are allowed to service their robots at a designated area under supervision. Only replacement of identical parts and batteries are allowed during the Servicing-Time.

4.4 Time Out

Each team will only be given one time-out of one minute in a game (of 3 matches). The time-out will apply after the match and only for the requesting team. Changing of battery is not allowed during the time-out.

4.5 Robot Handler

A participant is allowed to handle only one same robot throughout the event. Each robot should only have one same handler. The handler and robot will be identified during registration and caging.

5. CAGING

Robots shall be inspected and caged at least 1 hour before the start of the game.

6. CLONING:

- 6.1 In accordance with the spirit of the competition, clones will be identified during the "caging" procedure and shall be grouped to fight against each other during the preliminary stages.
- 6.2 Clones are robots with substantially identical physical appearance and working principles.
- 6.3 When in doubt, the decision of the Judges will be final.

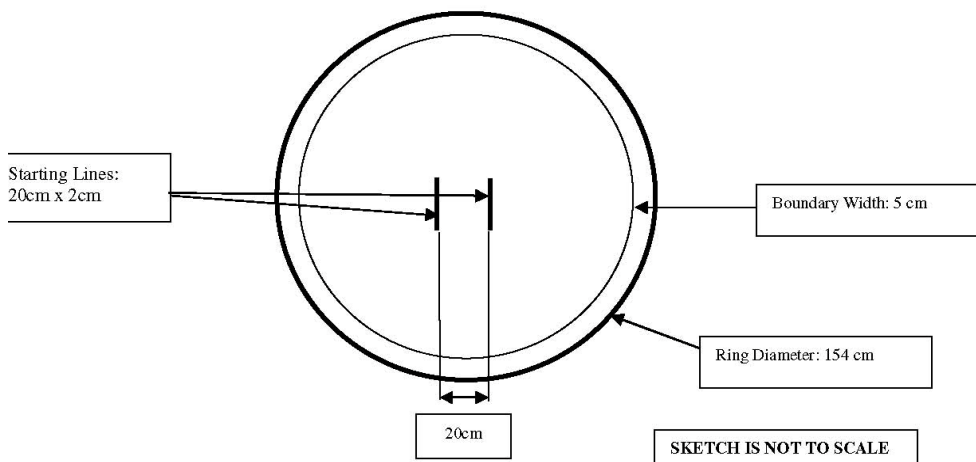

Figure 1

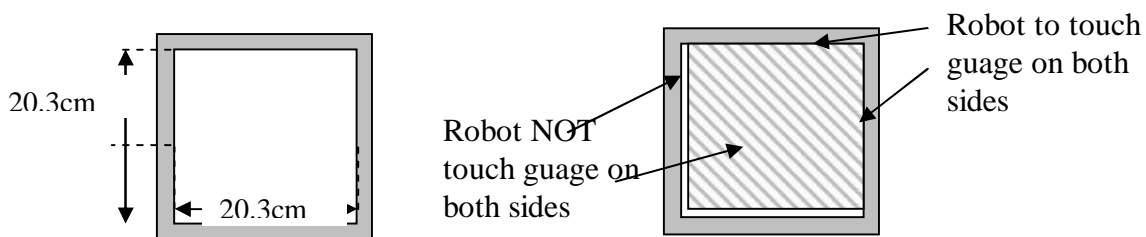

Figure 2: Caging Gauge

PICOMOUSE COMPETITION

INTRODUCTION

Picomouse is an autonomous mobile vehicle, which is able to navigate its way through an unknown maze from the start to the destination. It is also required to search for the best path between the start and the destination for the picomouse to run along this path in the shortest time.

The main challenge for picomouse designers is to build a fast moving wheel-driven robot. They need to work out the maze solving intelligence for the robot that is able to handle different maze configurations and compute the optimum path for the shortest fast-run time, and to control the robot to run at very fast speed without hitting the wall.

1. MAZE SPECIFICATIONS

- 1.1 The maze is be configured by placing walls along the grid-points formed by multiples of 9cm square. The squares are arranged in a 16 x 16 row-column matrix. The walls constituting the maze are in 2.5cm high and 0.6cm thick. Passageways between the walls are in 8.4cm wide. The boundary of maze is enclosed with walls.
- 1.2 White plastics make the maze walls. The maze platform is made by plywood and finished with black color matted paint. The maze walls shall reflect infra red light. The maze floor shall absorb it.

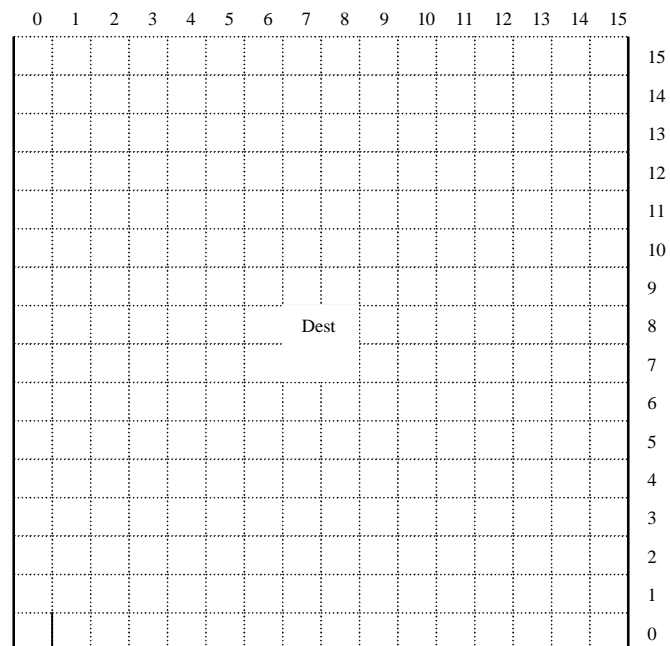

Figure 1: Start and Destination Points and Grid Lines for Maze

- 1.3 The starting position of the maze shall locate at one of the maze corner. There shall be three walls surrounding it. Its opening shall be towards destination that is the center of the maze, locating at the right of the starting square.
- 1.4 There are poles, in dimensions 0.6cm (length) x 0.6cm (width) x 2.5cm (height), locating at four Corners of each maze square. They are called lattice points. The maze shall be constituted such that there is at least one wall attached to each lattice point, except the lattice point that is locating at the center of the maze.
- 1.5 The accuracy of maze dimensions shall be within +/- 5% or 1cm; whichever is less. The assembly joints on the maze floor shall not involve steps of greater than +/- 0.25mm. The gaps between the walls of adjacent squares shall not greater than 0.5 mm.

2. PICOMOUSE SPECIFICATIONS

- 2.1 The length and width of any picomouse shall be within 12.5cm x 12.5cm. There is no limit on the height of the picomouse. The picomouse shall not change its dimensions while it is navigating along the maze.

- 2.2 The picomouse shall be fully autonomous and shall not receive any outside help throughout the contest.
- 2.3 The method of wall sensing is at the discretion of the designer, however; the picomouse shall not exert a force on any wall that is likely to cause damage. The method of propulsion is also at the discretion of the designer, provided that the energy source is non-polluted.
- 2.4 The picomouse shall not leave any parts on the passageway while navigating along the maze.
- 2.5 The picomouse shall not jump over, climb over, or damage the walls of the maze.

3. RULES FOR THE CONTEST

The crucial task of the picomouse is to navigate from the starting square to the destination square. This is called a run and the time taken is called the run time. Traveling from the destination back to the start is not considered as a run. The total time taken from the first time left the start square until the start of each run is also measured. This is called the search time. If the picomouse requires a manual assistance at any time during the contest, it is considered as a touch. A one-time penalty shall be added on those scores that are obtained after the touch. The run time, the search time and the touch penalty are to be used for the calculation of each score that the picomouse reaches the destination from the start successfully.

The picomouse competition is divided into three categories. They are the secondary schools (SSs) category, the junior colleges/institutes of technical education (JC/ITEs) category and the open (Open) category.

3.1 The Secondary Schools (SSs) Category

- 3.1.1 The SSs Category is opened for all full time students from secondary schools. Each school shall be limit to **Four** entries. Each entry shall not be more than **Six** students and must have its own picomouse. No picomouse shall be shared by any entries neither in this category nor the Open category.
- 3.1.2 Each entry shall be given time limit of 5 minutes or 6 crashes to contest on the maze. The picomouse may make as many runs as possible within time limit provided the picomouse does not crash more than 5 times.
- 3.1.3 The score of a picomouse shall be obtained by computing a handicapped time for each run as follows:

$$\begin{aligned} \text{Score of Current Run (reached the destination successfully)} &= \text{Run Time} + \\ &\quad \text{Search Penalty} + \text{Touch Penalty} \\ \text{Search Penalty} &= 1/60^{\text{th}} \text{ of the Search Time, in seconds} \\ \text{Touch Penalty} &= 2 \text{ seconds} \end{aligned}$$

For example, if a picomouse, after being on the maze for 4 minutes without being touched, starts a run that takes 20 seconds to reach the destination; the run will have a handicapped time score of $20 + 1/60^{\text{th}}$ of $(4 \times 60 \text{ seconds}) = 24$ seconds. However, if the picomouse has been touched before the run, an additional touch penalty of 2 seconds is added on giving a new handicapped time score of 26 seconds. The run with the fastest handicapped time score for each picomouse shall be the official time score of that picomouse. The accuracy of time score is to the nearest $1/100^{\text{th}}$ seconds.

- 3.1.4 The run time shall be measured from the moment that the picomouse leaves the starting square until it enters the destination square. A run shall be complete only if the whole of the picomouse enters the destination square.

- 3.1.5 A computer timing system with electronic triggering devices shall be used for measuring scores of each picomouse. The electronic triggering devices are located at the exit and entry of the starting square and the destination square respectively. The triggering device is constructed from the infra red transceivers. They are placed about 1cm above the maze floor. Any failure on the electronic triggering devices shall be back up by a manual timing system.
- 3.1.6 The starting procedure of each entry shall be simple and must not offer a choice of strategies to the handler. Pressing a “Start” button/switch once shall activate the picomouse. Throughout the duration of the given time limit, the handler shall not enter any information into the picomouse (such as to change the search strategy, the speed and the maze data).
- 3.1.7 The handler shall be given a setup time of 1 minute to calibrate the sensors, if required. However the handler shall not select any strategies and enter the maze data into the picomouse. The search time shall be started upon the expiry of setup time if the handler still continues to calibrate the sensors. Only **One** handler shall be allowed to operate the picomouse throughout the contest.
- 3.1.8 When the picomouse reaches the destination square, it may stop on its own and remains at the destination or continues to navigate to other parts of the maze or makes its own way back to the starting square. If the picomouse chooses to stop at the destination, it shall be manually lifted out and restarted by the handler. Manually lifted the picomouse out shall be considered as a touch to the picomouse. Therefore a touch penalty shall be added on the scores for all subsequent successful runs.
- 3.1.9 If a picomouse appears to be malfunctioning, the handler may ask the judges for the permission to abandon the run and restart the picomouse from the starting square. The handler shall not require restarting only if the picomouse makes a wrong turn; the judges’ decision is final. All handlers have to manage the technical problems within the time limit of 5 minutes given. No re-scheduling of the entry due to technical problems shall be allowed.
- 3.1.10 Before the complete maze is configured, all handlers have to register and cage their entries to the contest officials. Once the entry is caged, no replacement of any parts of the picomouse shall be allowed. Once a picomouse starts its run, no replacement of batteries shall be allowed otherwise considered as a touch to the picomouse and the touch penalty shall be added on for the subsequent scores made by the picomouse.

3.2 The Junior Colleges/Institutes of Technical Education (JC/ITEs) Category

- 3.2.1 The JC/ITEs Category is opened for all full time students from colleges/institutes. Each college/institute shall be limited to **Four** entries. Each entry shall not be more than **Six** students and must have its own picomouse. No picomouse shall be shared by any entries neither in this category nor the Open category.
- 3.2.2 Each entry shall be given a time limit of 5 minutes or 6 crashes to contest on the maze. The picomouse may make as many runs as possible within the time limit provided the picomouse does not crash more than 5 times.
- 3.2.3 The score of a picomouse shall be obtained by computing a handicapped time for each run as follows:

$$\text{Score of Current Run (reached the destination successfully)} = \text{Run Time} + \\ \text{Search Penalty} + \text{Touch Penalty}$$

Search Penalty = $1/60^{\text{th}}$ of the Search Time, in seconds

Touch Penalty = 2 seconds

For example, if a picomouse, after being on the maze for 4 minutes without being touched, starts a run that takes 20 seconds to reach the destination; the run will have a handicapped time score of $20 + 1/60^{\text{th}}$ of $(4 \times 60 \text{ seconds}) = 24$ seconds. However, if the picomouse has been touched before the run, an additional touch penalty of 2 seconds is added on giving a new handicapped time score of 26 seconds. The run with the fastest handicapped time score for each picomouse shall be the official time score of that picomouse. The accuracy of time score is to the nearest $1/100^{\text{th}}$ seconds.

- 3.2.4 The run time shall be measured from the moment that the picomouse leaves the starting square until it enters the destination square. A run shall be complete only if the whole of the picomouse enters the destination square.
- 3.2.5 A computer timing system with electronic triggering devices shall be used for measuring scores of each picomouse. The electronic triggering devices are located at the exit and entry of the starting square and the destination square respectively. The triggering device is constructed from the infra red transceivers. They are placed about 1cm above the maze floor. Any failure on the electronic triggering devices shall be back up by a manual timing system.
- 3.2.6 The starting procedure of each entry shall be simple and must not offer a choice of strategies to the handler. Pressing a “Start” button/switch once shall activate the picomouse. Throughout the duration of the given time limit, the handler shall not enter any information into the picomouse (such as to change the search strategy, the speed and the maze data).
- 3.2.7 The handler shall be given a setup time of 1 minute to calibrate the sensors, if required. However the handler shall not select any strategies and enter the maze data into the picomouse. The search time shall be started upon the expiry of setup time if the handler still continues to calibrate the sensors. Only **One** handler shall be allowed to operate the picomouse throughout the contest.
- 3.2.8 When the picomouse reaches the destination square, it may stop on its own and remains at the destination or continues to navigate to other parts of the maze or makes its own way back to the starting square. If the picomouse chooses to stop at the destination, it shall be manually lifted out and restarted by the handler. Manually lifted the picomouse out shall be considered as a touch to the picomouse. Therefore a touch penalty shall be added on the scores for all subsequent successful runs.
- 3.2.9 If a picomouse appears to be malfunctioning, the handler may ask the judges for the permission to abandon the run and restart the picomouse from the starting square. The handler shall not require restarting only if the picomouse makes a wrong turn; the judges’ decision is final. All handlers have to manage the technical problems within the time limit of 5 minutes given. No re-scheduling of the entry due to technical problems shall be allowed.
- 3.2.10 Before the complete maze is configured, all handlers have to register and cage their entries to the contest officials. Once the entry is caged, no replacement of any parts of the picomouse shall be allowed. Once a picomouse starts its run, no replacement of batteries shall be allowed otherwise considered as a touch to the picomouse and the touch penalty shall be added on for the subsequent scores made by the picomouse.

3.3 The Open Category

3.3.1 The Open Category is opened for all individuals from the universities, the polytechnics, the industry, and the private. **Participants who qualify to take part in the Secondary Schools Category are strictly not allowed to take part in the Open Category. Participants from JC/ITEs may be allowed to take part in the Open Category if**

- **the entries are not kit sets purchased or/and subsequently modified, and**
- **the entries have participated and performed well in the JC/ITEs category in the same year, and**
- **the entries are recommended and accepted for Open Category.**

Each entry shall not be more than **Six** participants and must have its own picomouse. No picomouse shall be shared by any entries.

3.3.2 Each entry shall be given a time limit of **5 minutes** to contest on the maze. Within this time limit, the picomouse may try up to a maximum of **5 runs**.

3.3.3 The score of a picomouse shall be obtained by computing a handicapped time for each run as follows:

$$\begin{aligned} \text{Score of Current Run (reached the destination successfully)} &= \text{Run Time} + \\ &\quad \text{Search Penalty} \\ \text{Search Penalty} &= 1/30^{\text{th}} \text{ of the Search Time, in seconds} \end{aligned}$$

For example, if a picomouse, after being on the maze for 4 minutes starts a run that takes 20 seconds to reach the destination; the run will have a handicapped time score of $20 + 1/30^{\text{th}}$ of $(4 \times 60 \text{ seconds}) = 28 \text{ seconds}$. The run with the fastest handicapped time score for each picomouse shall be the official time score of that picomouse. The accuracy of time score is to the nearest $1/100^{\text{th}}$ seconds.

3.3.4 The run time shall be measured from the moment that the picomouse leaves the starting square until it enters the destination square. A run shall be complete only if the whole of the picomouse enters the destination square.

3.3.5 The search time shall be measured from the moment that the picomouse leaves the starting square for the first time.

3.3.6 A computer timing system with electronic triggering devices shall be used for measuring scores of each picomouse. The electronic triggering devices are located at the exit and entry of the starting square and the destination square respectively. The triggering device is constructed from the infra red transceivers. They are placed about 1cm above the maze floor. Any failure on the electronic triggering devices shall be back up by a manual timing system.

3.3.7 The starting procedure of each entry shall be simple and must not offer a choice of strategies to the handler. Pressing a “Start” button/switch once shall activate the picomouse. Throughout the duration of the given time limit, the handler shall not enter any information into the picomouse (such as to change the search strategy, the speed and the maze data).

3.3.8 The handler may calibrate the sensors, if required. However the handler shall not select any strategies and enter the maze data into the picomouse. The time spent in calibration is counted towards the total given competition time of 5 minutes. Calibration is only allowed within the starting square. The picomouse is considered to have started its run if it moves

out of the starting square and triggers the electronic triggering devices. Only **One** handler shall be allowed to operate the picomouse throughout the contest.

3.3.9 When the picomouse reaches the destination square, it may continue to navigate to other parts of the maze or make its own way back to the starting square. No manual lifting of the picomouse at the destination is allowed.

3.3.10 The handler shall not touch the picomouse while the picomouse is running in the maze unless he is given permission by the judges to do so. If a picomouse appears to be malfunctioning, the handler may ask the judges for the permission to abandon the run and restart the picomouse from the starting square. The handler shall not require restarting only if the picomouse makes a wrong turn; the judges' decision is final. All handlers have to manage the technical problems within the time limit of 5 minutes given. No re-scheduling of the entry due to technical problems shall be allowed.

3.3.11 An extra run is considered to be used up whenever the handler touches the picomouse.

3.3.12 Before the complete maze is configured, all handlers have to register and cage their entries to the contest officials. Once the entry is caged, no replacement of any parts of the picomouse shall be allowed. Once a picomouse starts its run, no replacement of batteries shall be allowed.

4. CLONING (APPLIES ONLY TO OPEN CATEGORY)

4.1 In accordance with the spirit of the competition, clones among the winning entries will only be awarded one prize. Clones will be identified during the "caging" procedure.

4.2 Clones are robots with substantially identical physical appearance and working principles.

4.3 When in doubt, the decision of the Judges will be final.

ROBOT COLONY COMPETITION

1. OBJECTIVE

The objective of the competition is to build a self-contained autonomous cooperative pair of mobile robots that are able to search out and detect coloured pellets which must be collected and deposited at a designated pocket for each colour. 2 different coloured pellets are available for collection on the platform. The goal is to collect and deposit equal number of the 2 different colored pellets. Points will be awarded for correctly deposited pellets and deducted for wrongly deposited pellets. Points will also be deducted for unequal number of the 2 different colored pellets deposited. The performance of each team is decided, at the end of the run time of 5 mins, by the total points accumulated. In the event that all pellets are delivered to their designated pockets before the run time of 5 mins has expired, then the shortest time taken will be considered as a further score.

2. SPECIFICATIONS FOR PLATFORM

2.1 The platform will cover a square area of dimensions 2.3m x 2.3m as shown in Fig 1. There are no walls bordering the platform.

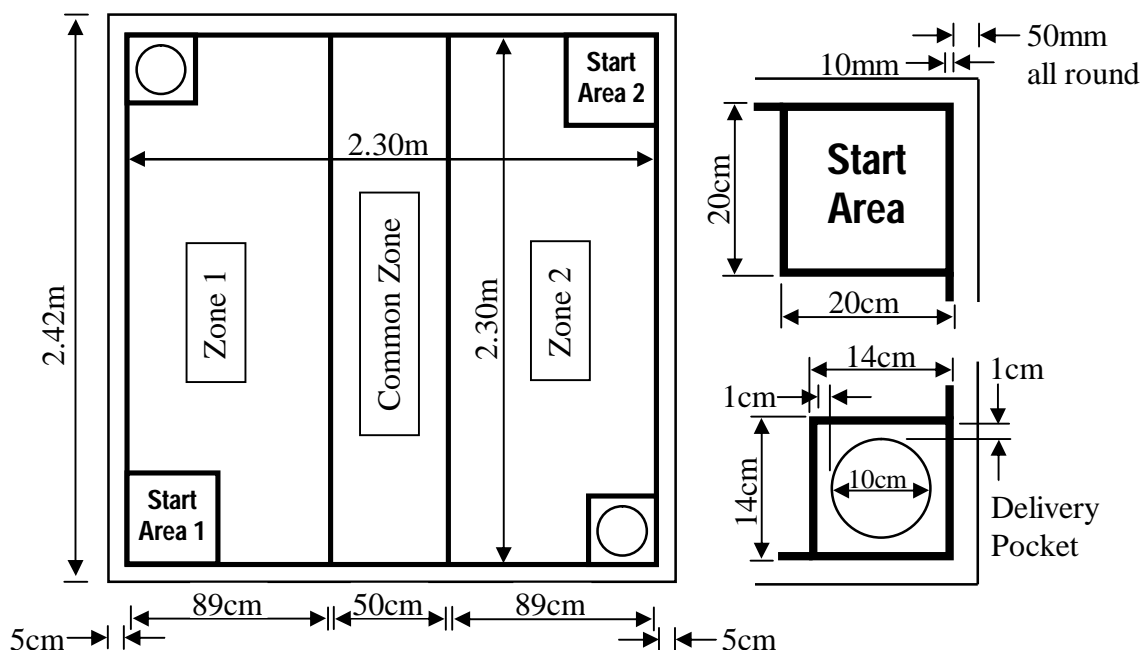

Figure 1 Robot Colony Platform

2.2 The starting locations for the 2 robots must be at the 2 Start Areas. Delivery pockets shall be located at the 2 opposite corners. The color for each designated delivery area will be decided by the judges during the event. A 2.3m x 50cm area in the centre of the platform is designated as the “Common Zone”. This zone, delivery pockets and start square will have tape bounding them as shown in the figure. The floor of the platform shall be made of wood and finished with matt black paint and the lines taped out with 1cm wide yellow reflective tape. The specifications of this tape are as follows:

Material Name : Fasign reflective sheeting.

Company: Fasign Reflective films.

Colour : Yellow.

Local Rep details: Teck Seng Enterprises Pte LTD

14, Eunos Tech Park, Tel: 6742-3035, Fax: 6842-0233

- 2.3 A total of 30 of each coloured pellets will be placed (total 60). The orientation and layout of the coloured pellets placed on any part of the colony platform will be decided by the judges but each setup will be kept consistent for all teams.

3. COLOURED PELLET SPECIFICATION

- 3.1 The coloured pellets will have a diameter of 25.4mm (1 inch) and have a general height of 20mm +/- 2mm height variation. (See figure 2)

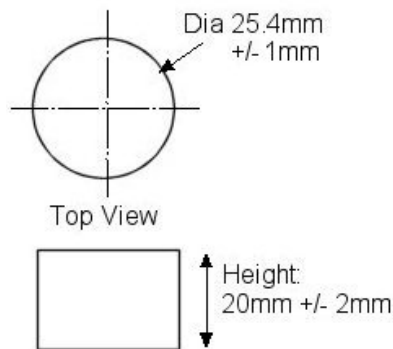

Figure 2 Specification of coloured pellet

- 3.2 The material specification of the pellets is as follows:

Green (Nyloil)	RS 771-162
Blue (Tuffset)	RS 771-538 (RS Catalog April 2006/2007 - Pg 1693)

4. ROBOT SPECIFICATION

- 4.1 The length and width of the robot shall be restricted to a square region of 15 cm x 15 cm. During collection and delivery, feelers or extending probes, collecting arms etc. of the robot should not extend beyond the 15cm x 15 cm area. There is no restriction on the height of the robot. The weight of each robot is restricted to 5 kg.
- 4.2 The robots must be fully autonomous with their own locomotion and must receive no outside help. The robots are however free to communicate wirelessly with each other for cooperative benefits.
- 4.3 One robot must be designated as a “Master” and the other a “Slave”. The “Master” will command/instruct the “Slave” to move out of the Start Area at the beginning of the competition. See “Section 5 - Rules for the Contest” for further details.
- 4.4 Each robot must have color identification patch/patches of a minimum size of 25cm² each that is visible to the judges at all times and robot orientation. The color of the patch corresponds to the color of the pellets the robot is disposing.
- 4.5 The methods, collection and delivery are at the discretion of the builder. The method of propulsion is at the discretion of the builder, provided the power source is non-polluting.
- 4.6 If any part of a robot should drop off while it is negotiating the platform, it will not be allowed to continue its run on the platform and will be removed.

5. RULES FOR THE CONTEST

- 5.1 The goal of the robot pair is to detect various coloured pellets placed in any area of the platform and to deliver them to their respective pockets. The collection and delivery strategy is left to the robot builder. The robot builder is free to decide on the technique for identifying the colour, detecting the location of the coloured pellets on the platform, and then deciding on a collection and delivery strategy to take it to the respective area. A cooperative strategy

between the two robots can be used to increase the productivity of the collection and delivery of the colour pellets.

5.2 The robots are restricted in its range of exploration. The robot starting in Start Area 1 is free to move within Zone 1 and the Common Zone only, and the robot starting in Start Area 2 is free to move within Zone 2 and the Common Zone. The robot starting in Start Area 1 is not allowed to go into Zone 2 and the robot starting in Start Area 2 is not allowed to go into Zone 1. Stray robots and robots which interfere with pellets not in their allowed zones will have to be restarted in their corresponding Start Area and the pellets it is carrying/ moving/ pushing removed from the platform. Robots are only allowed to deposit pellets into the delivery pocket in its own Zone, i.e. a robot starting in Start Area 1 can only deposit pellets into the delivery pocket in Zone 1 and not allowed to deposit pellets in the delivery pocket in Zone 2.

5.3 A robot (free moving, searching, collecting, pushing pellets) in the common zone when reaching its separator line (separating its allowed and disallowed zones) must take evasive actions to prevent it from going into the disallowed zone. Evasive actions include stopping & turning back/away, stopping & reversing or steering away. These actions must take the robot further into its allowed zone and not further into the disallowed zone. These actions will look no different to those when it is reaching the perimeter line which prevents the robot from falling off the arena.

A robot moving/steering along its separator line can have a small portion of it crossing into its disallowed zone. This portion will be "identical" to that amount when it is moving/steering along the perimeter lines. So the way the robot handles the separator and perimeter lines are identical. A robot moving/steering along the separator line may touch/brush pellets in the disallowed zone but it is not allowed to push the pellet along in front of it and not allowed to collect the pellet. A robot taking evasive actions (as described above) when reaching the separator line may touch/brush pellets in the disallowed zone but it is not allowed to collect it.

This provision is for handling between zone peripheral issues and must not be systematically exploited to gain unfair advantages.

5.4 Each correctly delivered pair of colour pellets in its colour delivery area will be awarded 2 points, and each incorrect colour pellet in any pocket will have 1 point deducted from the total score. For every pellet which does not form a successful pair will have 1 point deducted from the total score. One green and one blue pellet are deemed a pair of pellets.

Example: Blue Delivery Area: 10 Blue / 3 Green collected and deposited

Green Delivery Area: 15 Green / 1 Blue collected and deposited

Scoring: 10 successful pairs = 20 points

3 + 1 wrong pellets = -4 points

5 unsuccessful pair pellets = -5 points

Total Score = 11 points.

5.5 The competition time for each robot pair starts from the moment the judges give the signal to move off from the starting area.

5.6 At the end of the competition time, only pellets in the pockets will be counted. Pellets that are still held by or left in/on the robots will not be counted.

5.7 The starting procedure of the robot should be simple and must not offer a choice of strategies to the handler. The robots shall be placed within the Start Areas. The "Master" robot shall be started by pressing a "start" button once by one handler under the officials' instructions. The "Master" robot will then instruct/command the "Slave" robot to start.

Failure of the “Slave” robot to start immediately after the Master has started (moved off) at the beginning of the competition will incur a penalty of 10 points and constitute 1 restart. Manual starting of any robot after the initial Master start will constitute 1 restart. Throughout the duration of the robot's performance, the handler shall not enter any information into the robot.

- 5.8 Each team is allowed a maximum of 5 restarts. All restarts require the approval of the presiding Judges before the robot(s) can be removed from the arena. The team will be disqualified if the robots were handled within the arena without approval.
- 5.9 In general, restarts are only allowed when robots crash or are out of control.
- 5.10 Robots that are restarted in the start area will have any coloured pellet that it is carrying or moving/pushing by the robot be removed from the platform. The pellets will not be returned back to the platform. The final decision of which exact pellets are to be removed will rest with the judges.
- 5.11 Team members will not be allowed to handle the coloured pellets. Only officials are allowed to handle the coloured pellets in any situation (e.g. to clear the delivery area, re-site a coloured pellet etc...)
- 5.12 If a robot handler elects to retire because of technical problems, there will be no appeal for a second attempt.
- 5.13 If only one robot remains in the competition, there will be no more restarts for the team.
- 5.14 Only one pair of robot handlers per entry is allowed. The same robot handlers from a previous entry are not allowed to handle another entry's robots.
- 5.15 A robot which correctly delivers at least 5 pairs of pallets qualifies itself for a prize. Prizes will only be awarded to the top 3 teams from different institutions with the top 3 positive overall scores of more than 10.

6. CAGING

- 6.1 All robot entries will be caged 15 minutes before the start of the event.
- 6.2 Robot entries are not allowed to charge the batteries of the robot during caging but are allowed to cage spare batteries along with their robots.

7. CLONING

- 7.1 In accordance with the spirit of the competition, clones among the winning entries will only be awarded one prize. Clones will be identified during the "caging" procedure.
- 7.2 Clones are robots with substantially identical physical appearance and working principles.
- 7.3 When in doubt, the decision of the Judges will be final.

8. TIE-BREAK

Should a tie break be required because both teams have equal points, the tie break will be decided on the team which had the fastest successful 1st pellet delivery time.

INTELLIGENT ROBOT CONTEST (TECHNICAL COURSE)

1. OBJECTIVE

The participating team is required to design and build either a single or multiple autonomous robots to collect 25 objects in a competition arena. The objects consist of 9 yellow balls, 7 blue empty steel cans and 9 red boxes. The collected objects are to be delivered to 3 different goal-containers according to their respective colours within 6 minutes. The objects are placed at the right section of the competition arena according to a pattern unknown to the robots. The competing robots either go through the tunnel that is 390mm in height or take a longer path to reach the object collecting area.

2. ROBOT SPECIFICATIONS

The overall size of all participating robots must be **less than** 450mm (Length) x 450mm (Width) x 900mm (Height). The overall weight of all robots must be **less than** 20Kg. Each robot must have only **one** power on/off switch and **one** start/stop switch. The procedure to start the robot can be found in the Section 6.2, Competition Rules. All robots operate autonomously or they perform corporately among themselves to achieve the task.

Please note that no external input on selection of tactics on any robot is permitted throughout the competition. The use of external power is also not allowed.

3. COMPETITION FIELD SPECIFICATION

A 3D view of competition arena is shown in figure 1. The 2D drawings with dimensions and markings of the field, the goal-container and the tunnel are shown in figure 3, 4 and 5.

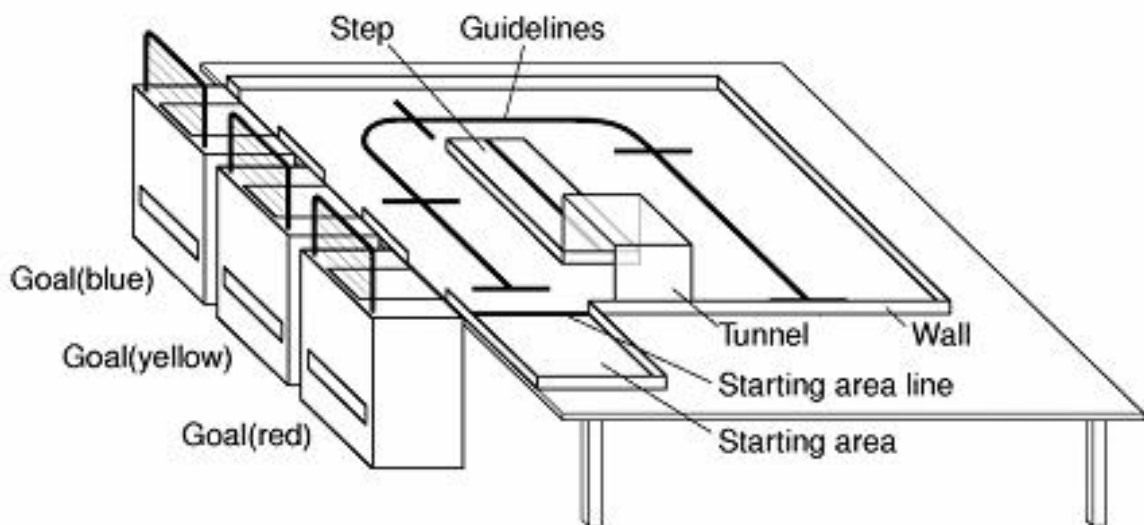

Figure 1: The 3D View of Competition Arena

4. COMPETITION LAYOUT

Figure 2 shows an example of the competition layout. Basically, there are 10 regions of which each would have two randomly placed objects. The minimum distance between two random objects within a region is 5cm. The dimension of the region is 30cm x 20 cm. The positions of these regions are shown in the figure. Note that the only object that is made known its position before the competition is the ball that is placed at the bottom right corner.

Placement of Boxes

- Stand-alone Boxes will rest their smallest areas on the platform
- Boxes that are part of the tower will rest their largest areas on the platform
- In both cases, the longer side of the resting surface will be parallel to the Y axis.

The final object layout will be decided by the panel of judges before the competition starts and the same layout will be used for all the contestants through out the competition.

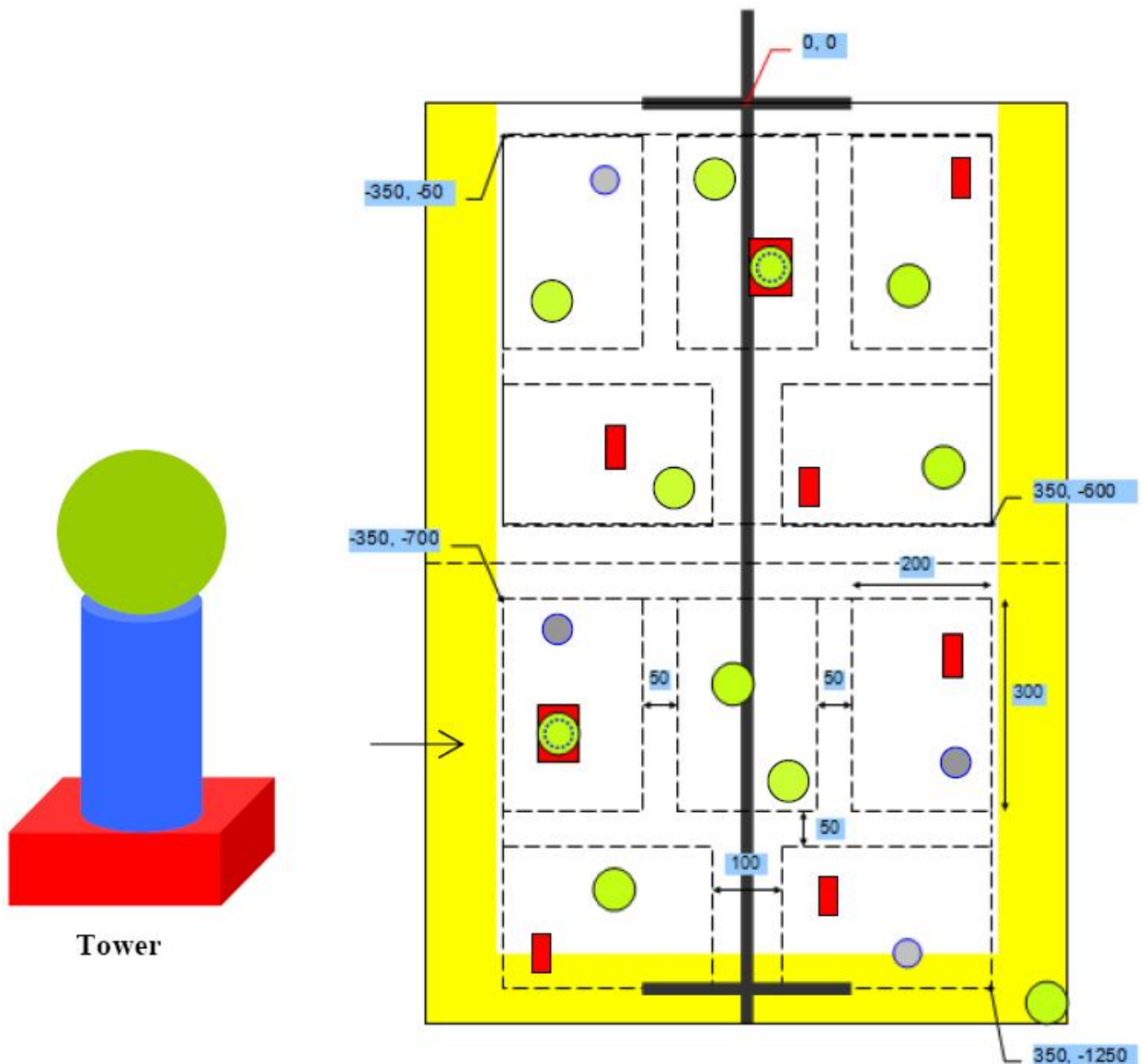







Figure 2: The Competition Layout

5. OBJECT SPECIFICATIONS

The table below shows the specification and other relevant information on the three objects used in this competition. Please note that all the specifications will be within the range of $\pm 5\%$ error.

	Balls	Steel Cans	Boxes
Colour	Yellow 	Blue. The side is to be wrapped in 3M Blue Tape. 	Red. The entire box is to be wrapped in 3M Red Tape. 
Dimension	65mm in diameter	53mm in diameter 104 mm in height	90mm x 60 mm x 34 mm
Weight	58g	39g	100g
<p>Please note that the following items serve only as the examples of commercial products that meet the above specification. SRG reserves the right to use any type of object in the competition so long as it meet the specification.</p>			
Brand	Wilson / Dunlop	Sangaria	Custom-Made
Type	Championship 	Tomato Juice, Orange Juice, Milk Tea, etc 	
Sold at	Royal Sporting House or any sports utility shops	DAISO at IMM or Plaza Singapura	Robotic Games Society, Singapore
Tape		471 3M Blue Tape 2" 	
		Available from Ever Win Enterprises 73 Tiong Bahru Rd, Singapore 168725 Tel: 65-62216810	

6. COMPETITION RULES

- 6.1. Each entry is given 1-minute setup time to get ready and 6-minute competition time to perform. Upon the setup time is over, the handler may request for 1-minute timeout otherwise the competition time starts even through the entry is not ready. Only one timeout is given to each entry.
- 6.2. The handler has to place all the competing robots within the starting area and adheres to the following procedure when starting the robot:
 - 6.2.1 Power up the robot. The robot must be off prior to this.
 - 6.2.2 Press the start/stop switch once to start the competition.

- For multiple robots, handler has to press the start/stop switches on each robot together or one after another without any waiting interval.
- 6.3. Once the robot is pressed, it has to leave the starting area within 30 seconds otherwise it is judged as a crash. For multiple robots, at least one robot has to leave the starting area within 30 seconds otherwise the entry is judged as a crash.
 - 6.4. Each entry is given 5 chances of crash. A crash is defined as whenever a competing robot is not able to perform such as any robot does not move or jam in the arena. When the handler wishes to restart the robot after a crash occurs, the handler needs to seek the judge's permission to stop the robot. For the multiple robots, all robots must stop and restart. Before restart, the handler needs to empty any objects retained by the robots.
 - 6.5. For the multiple robots using r.f. communication among them, the handler has to anticipate the interference arising in the environment. If any case happens and the interference is not able to resolve, the handler needs to bear with it to proceed for the competition.
 - 6.6. The score shall be calculated as follows:
 - 6.6.1. The points given to each correctly delivered objects: Can = 6, Ball = 4, Box =6.
 - 6.6.2. The penalty points for each incorrectly delivered object is -4.
 - 6.6.3. Only robots which have correctly delivered one of each object qualify for a prize.
 - 6.7. If there is a tie, the factors to determine the winner will be as follows:
 - 6.7.1. For entries with perfect score, i.e. all objects correctly delivered, the time taken to deliver all objects will be used. This is defined as the time from which the start/stop switch is pressed to the time the robot that delivers the last object completely crosses the line to the starting area.
 - 6.7.2. For non-perfect scorers, the time taken to correctly deliver the first object will be used instead.
 - 6.8. Repairing of robots is allowed, but with no extra time given. It must be done in the presence of the judges. The strategy must remain the same before and after repairing. Changing of batteries is not allowed.
 - 6.9. In the event of any ambiguity in the competition rules, the judge's interpretation shall prevail. Should a situation arise that is not addressed in the rules, the judges will decide on the matter and their decision will be final.

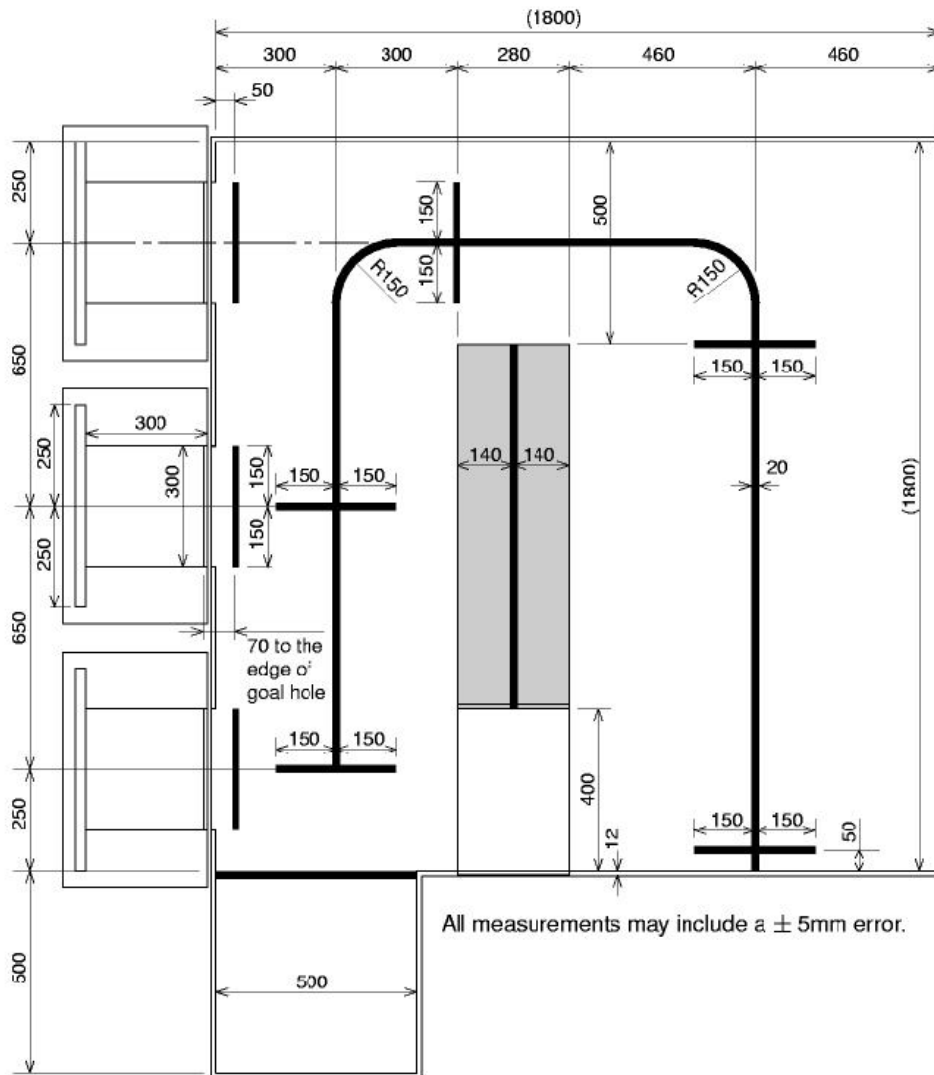

- Field : the floor: Made by lauan [19], Thickness: 15mm
- : the wall: Made by lauan [19], Thickness: 12mm
- : Color: horizontal surface=white vertical surface=yellow (painted)
- Step : Made by lauan [19], Height: 40mm
- : Color: horizontal surface=white vertical surface=yellow (painted)
- Tunnel : Made by acrylic plate, Thickness: 10mm
- Guiding Line : vinyl tape, Width: 19mm, Max. Error of width: -2mm, Color: black
- Box of Goal : Thickness: 9mm, Made by lauan [19] , Color: blue, yellow and red (painted)
- Bucket : plastics
- Net : Green Net for baseball with 40mm×40mm stitch
- Frame of the Net : pipes (dimeter is 28mm)
- Starting Area Line : Same with the Guiding Line

Figure 3: The 2D Drawing of Competition field

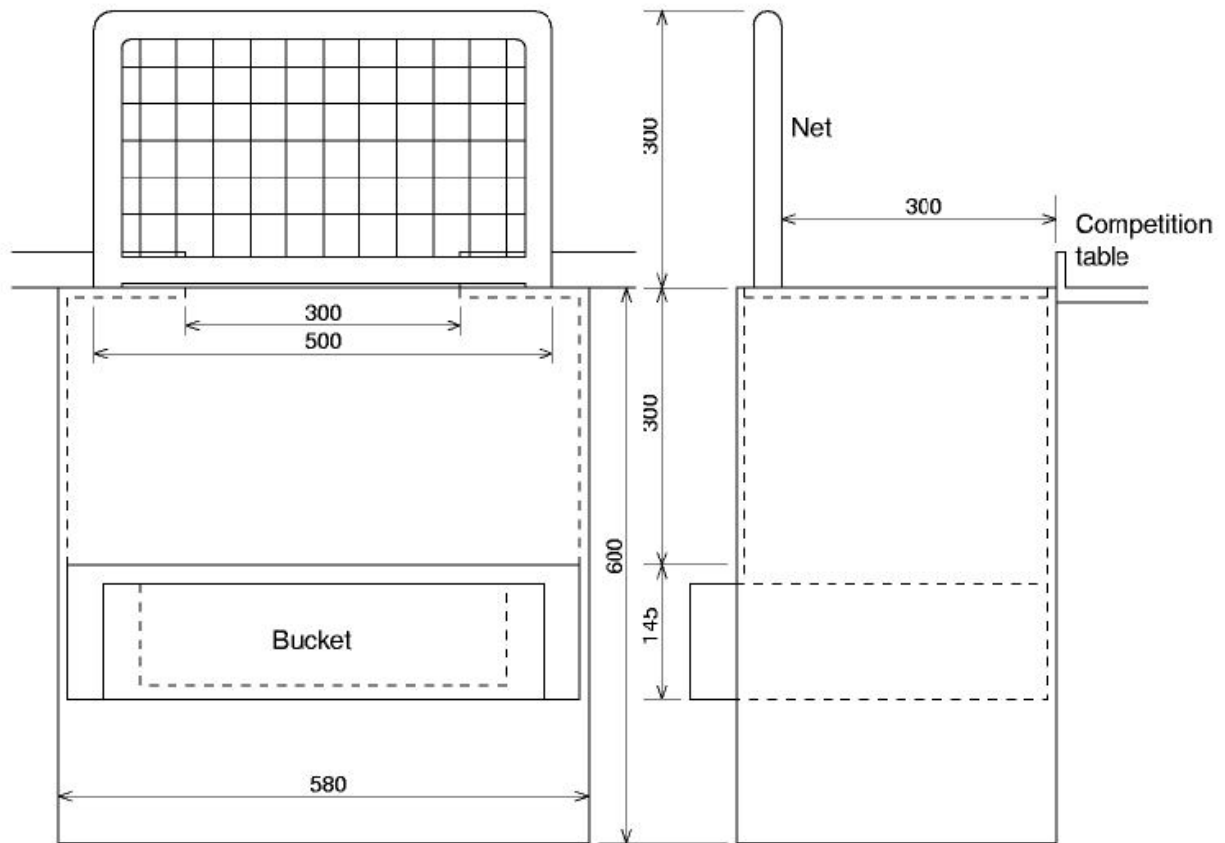

Figure 4: The Drawing of Goal-container

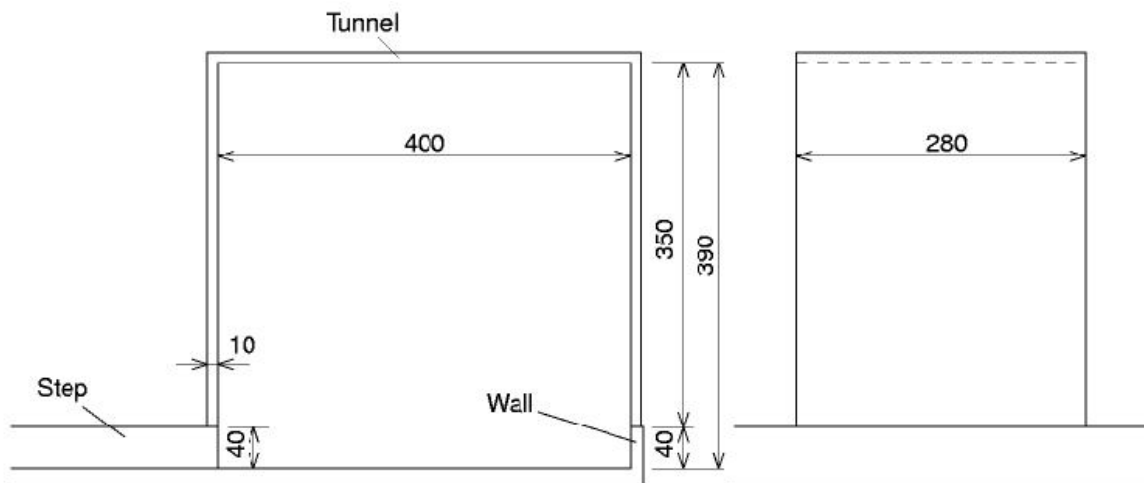

Figure 5: The Drawing of Tunnel

1.4 The Goal Line and Goal Area

The goal line is the line just in front of the goal which is 40cm long. The goal areas (The region A of Figure 1) shall comprise of the area contained by the rectangle (sized 50cm X 15cm in front of the goal) and the goal itself.

1.5 The Penalty Area

The penalty areas (The region B of Figure 1) shall comprise of areas contained by the rectangle (sized 80cm X 35cm in front of the goal.) The penalty area contains the goal area. The arc is not part of the penalty area.

1.6 The Ball

An orange golf ball shall be used as the ball, with 42.7mm diameter and 46g weight.

1.7 The Field Location

The field shall be located indoors.

1.8 Vision and Lighting

1.8.1 The lighting conditions should be more than 500 Lux anywhere on the playground. The lighting should be diffuse and evenly distributed. A flicker free lighting is recommended.

1.8.2 In order to identify the robots and the ball on the playground, a vision system can be used. Only one camera per team may be used.

1.8.3 The location of a team's camera or sensor system should be restricted to over and above their own half of the field including the center line, so that the camera need not to be moved after the side change at halftime. If both teams wish to keep their cameras over and above the center circle of the playground, they shall be placed side by side, equidistant from the centerline and as close to each other as possible. The location of the overhead camera or sensor system should be at a height of 2.5 m.

2. THE PLAYERS

2.1 The Overall System

A match shall be played by two teams, each consisting of five robots. One of the robots can be the goalkeeper (Section 2.2.5). Three human team members are allowed on stage. Only one designated team member is allowed to access the playground during a game (if instructed so by the referee), except during timeouts and halftime. The whole equipment for a team needed to play should fit on a single 120 cm x 80 cm table.

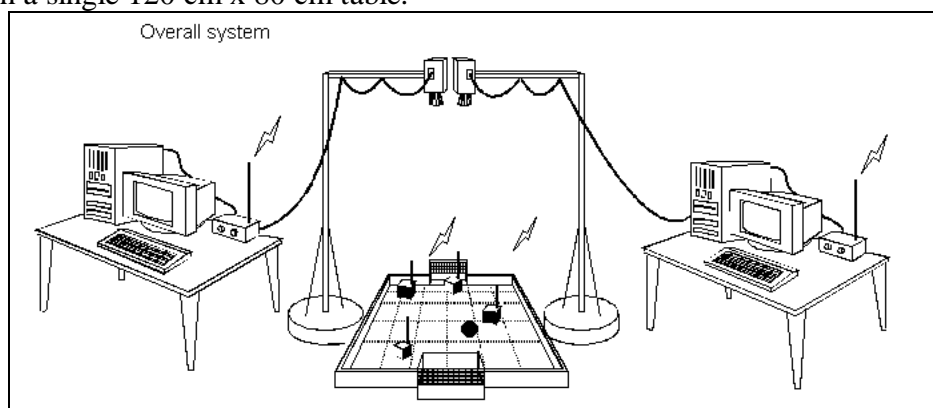

Figure 2: Overall System

2.2 The Robots

- 2.2.1 The size of each robot shall be limited to 7.5cm X 7.5cm X 7.5cm. The height of the RF communication antenna will not be considered in deciding a robot's size. The robots are allowed to equip with arms, legs etc., but they must comply with the size restrictions even with the appendages fully expanded.
- 2.2.2 The robots' weight may not exceed 650 g.
- 2.2.3 To enable infrared sensing a robot's sides should be colored light, except at regions necessarily used for robot functionality, such as those for sensors, wheels or a ball catching mechanism.
- 2.2.2 The topside of a robot must not be colored in orange. A color patch either blue or yellow, as assigned by the organizers, will identify the robots in a team. All the robots must have (at least) a 3.5cm X 3.5cm solid region of their team color patch, blue or yellow, visible on their top. A team's identification color will change from game to game, and the team color patch used should be detachable. When assigned with one of the 2-team colors (blue or yellow), the robots must not have any visible patches of those colors used by an opponent team.
- 2.2.3 The teams are recommended to prepare a minimum of 10 different color patches, other than blue and yellow, for individual robot identification.
- 2.2.4 To enable infrared sensing a robot's sides should be colored light, except at regions necessarily used for robot functionality, such as those for sensors, wheels and the ball catching mechanism. The robots should wear uniforms and the size of which shall be limited to 8cm X 8cm X 8cm.
- 2.2.5 A robot within its own goal area (Section 1.4) shall be considered as the "goalkeeper". The goalkeeper robot shall be allowed to catch or hold the ball only when it is inside its own goal area or penalty area.
- 2.2.6 Each robot must be fully independent, with powering and motoring mechanisms self-contained. Only wireless communication shall be allowed for all kinds of interactions between the host computer and a robot.
- 2.2.7 The robots are allowed to equip with arms, legs, etc., but they must comply with the size restrictions (Section 2.2.1) even after the appendages fully expanded. None of the robots, except the single designated goalkeeper, shall be allowed to catch or hold the ball such that more than 30% of the ball is out of view either from the top or from the sides. (See Figure 3.)

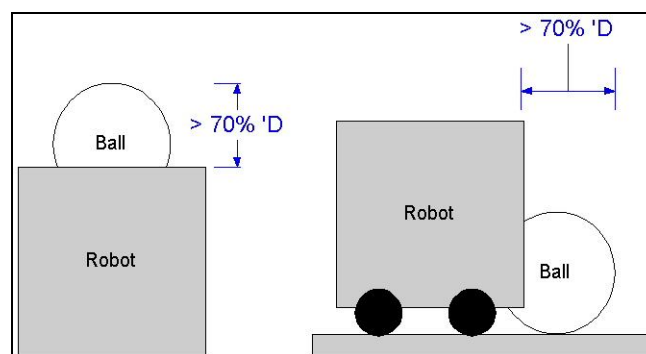

Figure 3: Catching/Holding of Ball

- 2.2.8 While a match is in progress, at any time the referee whistles the human operator should stop all robots using the communication between the robots and the host computer.

2.3 Substitutions

Two substitutes shall be permitted while a game is in progress. At half time, unlimited substitutions can be made. When a substitution is desired while the game is in progress, the

concerned team manager should call 'time-out' to notify the referee, and the referee will stop the game at an appropriate moment. The game will restart, with all the robots and the ball placed at the same positions as they were occupying at the time of interrupting the game.

2.4 Time-out

The human operator can call for 'time-out' to notify the referee. Each team will be entitled for four time-outs in a game and each shall be of 2 minutes duration.

3. TRANSMISSIBLE INFORMATION

The manager, the coach or the trainer may transmit certain commands directly from the remote host computer to their robots. It is not allowed to transmit commands such as reset signals to stop any/all of the robots or restart signals, without the permission from the referee. Any other information, such as game strategy, can be communicated to robots only when a game is not in progress. The human operator should not directly control the motion of their robots either with a joystick or by keyboard commands under any circumstances. While a game is in progress the host computer can send any information autonomously.

4. THE VISION SYSTEM

In order to identify the robots and the ball on the playground, a vision system can be used. The location of a team's camera or sensor system should be restricted to, over and above their own half of the field including the center line, so that the camera need not have to be moved after the side change at halftime. If both teams wish to keep their cameras over and above the center circle of the playground, they shall be placed side by side, equidistant from the centerline and as close to each other as possible. The location of the overhead camera or sensor system should be at a height of 2.5m or higher.

5. GAME DURATION

- 5.1 The duration of a game shall be two equal periods of 5 minutes each, with a half time interval for 10 minutes. An official timekeeper will pause the clock during substitutions, while transporting an injured robot from the field, during time-out and during such situations that deem to be right as per the discretion of the timekeeper.
- 5.2 If a team is not ready to resume the game after the half time, additional 5 minutes shall be allowed. Even after the allowed additional time if such a team is not ready to continue the game, that team will be disqualified from the game.

6. GAME COMMENCEMENT

- 6.1 Before the commencement of a game, either the team color (blue/yellow) or the ball shall be decided by the toss of a coin. The team that wins the toss shall be allowed to choose either their robot's identification color (blue/yellow) or the ball. The team who receives the ball shall be allowed to opt for their carrier frequency band as well.
- 6.2 At the commencement of the game, the attacking team will be allowed to position their robots freely in their own area and within the center circle. Then the defending team can place their robots freely in their own area except within the center circle. With a signal from the referee, the game shall be started and all robots may move freely.
- 6.3 At the beginning of the first and second halves, and after a goal has been scored, the ball should be kept within the center circle and the ball should be kicked or passed towards the team's own side. If this is not done, the kick-off must be repeated. If the kick-off is done incorrectly again, a free-kick will be awarded to the other team.
- 6.4 At the beginning of the game or after a goal has been scored, the game shall be commenced/continued, with the positions of the robots as described in Section 6.2.

6.5 After the half time, the teams have to change their sides.

7. METHOD OF SCORING

7.1 The Winner

A goal shall be scored when the whole of the ball passes over the goal line. The winner of a game shall be decided on the basis of the number of goals scored.

7.2 The Tiebreaker

7.2.1 In the event of a tie after the second half, the winner will be decided by the sudden death scheme. The game will be continued after a 5 minutes break, for a maximum period of three minutes. The team managing to score the first goal will be declared as the winner. If the tie persists even after the extra 3 minutes game, the winner shall be decided through penalty-kicks.

7.2.2 Each team shall take three penalty-kicks, which differs from Section 11 in the following aspects:

- a) only a kicker and a goalkeeper are allowed on the playground, and
- b) the attacking robot may not touch the ball again after the goalkeeper has touched it.

After the referee's whistle, the goalkeeper may come out of the goal area. In case of a tie even after the three-time penalty-kicks, additional penalty-kicks shall be allowed one-by-one, until the winner can be decided. A penalty-kick will be completed, when any one of the following happens:

- (i) the ball has entered and left the goal area, or
- (ii) the goalkeeper catches the ball, or
- (iii) a foul occurs, or
- (iv) ten (10) seconds pass after the referee's whistle, or
- (v) the attacker touches the ball again after the goalkeeper has touched it

8. FOULS

A foul will be called for in the following cases.

8.1 Colliding with a robot of the opposite team, either intentionally or otherwise: the referee will call such fouls that directly affect the play of the game or that appear to have potential to harm the opponent robot. When a defender robot intentionally pushes an opponent robot, a free kick will be given to the opposite team. It is permitted to push the ball and an opponent player backwards provided the pushing player is always in contact with the ball.

8.2 It is permitted to push the goalkeeper robot in the goal area, if the ball is between the pushing robot and the goalkeeper. However pushing the goalkeeper into the goal along with the ball is not allowed. If an attacking robot pushes the goalkeeper along with the ball into the goal or when the opponent robot pushes the goalkeeper directly then the referee shall call goal kick as goalkeeper charging.

8.3 Attacking with more than one robot in the goal area of the opposite team shall be penalized by a goal kick to be taken by the team of the goalkeeper. A robot is considered to be in the goal area if it is more than 50% inside, as judged by the referee.

8.4 Defending with more than one robot in the goal area shall be penalized by a penalty-kick. (A robot is considered to be in the goal area if it is more than 50% inside, as judged by the referee.) An exception to this is the situation when the additional robot in the goal area is not

there for defense or if it does not directly affect the play of the game. The referee shall judge the penalty-kick situation when the additional robot in the goal area is not there for defense or if it does not directly affect the play of the game. The referee shall judge the penalty-kick situation.

- 8.5 It is referred to as handling, as judged by the referee, when a robot other than the goalkeeper catches the ball. It is also considered as handling, if a robot firmly attaches itself to the ball such a way that no other robot is allowed to manipulate the ball.
- 8.6 The goalkeeper robot should kick out the ball from its goal area (defined in Section 1.4) within 10 seconds. The failure to do so will be penalized by giving a penalty kick to the opposite team.
- 8.7 Giving a goal kick to the team of the goalkeeper will penalize the intentional blocking of a goalkeeper in its goal area.
- 8.8 Only the referee and one of the human members of a team (manager, coach or trainer) shall be allowed to touch the robots. The award of a penalty-kick shall penalize touching the robots without the referee's permission.
- 8.9 A penalty kick is awarded against a team whenever three robots of the opponent team are all together staying inside the penalty area while the ball is in play.(Only the robot whose 50% or more of the body enters the penalty area should be considered as staying inside the penalty area). In case a robot crosses through its own penalty area without intension of defense, this robot shall not be considered as staying inside the penalty area

9. PLAY INTERRUPTIONS

The play shall be interrupted and relocation of robots shall be done by a human operator, only when:

- 9.1 A robot has to be changed.
- 9.2 A robot has fallen in such a way as to block the goal.
- 9.3 A goal is scored or a foul occurs.
- 9.4 Referee calls goal kick (Section 12) or free-ball (Section 13).

10. FREE KICK (SEE FIGURE 4)

When a defender robot intentionally pushes an opponent robot, a free kick will be given to the opposite team (Sec 8.1). The ball will be placed at the relevant free kick position (FK) on the playground (Figure 1). The robot taking the kick shall be placed behind the ball. The attacking team can position its robots freely within

Figure 4 : Free-Kick

Picture shows Middle League, similar in Large league.
Circle radius in Large League: 30 cm

Free-Kick situations:

- 1) Defender intentionally pushes opponent (with ball or when it affects the game).
- 2) Ramming opponent in a way that might damage it.
- 3) Any robot other than the goalkeeper catches the ball. Or a single robot or single team obstructs the ball for more than 10 seconds.
- 4) Large League only: Violation of rule 4.3.4 (zone rule)

Robot and ball positions:

- 1) Ball on the position where the foul has happend, but outside of penalty area.
Large League only: If the free-kick has been called because of violation of rule 4.3.4, the free-kick ball position is stated in Appendix A (equidistant between free-ball points)
- 2) All defending robots out of 20 cm (Middle L.) or 30 cm (Large L.) radius circle.
- 3) Defending team places first.
- 4) No defending robot may move into the circle before the ball has been moved or 10 seconds have passed.

12.1.3 When an opponent robot intentionally blocks the goalkeeper in its goal area (section 8.7.)

12.1.4 When the goalkeeper catches the ball with its appendages (if any) in its own goal area.

12.1.5 When a stale-mate occurs in the goal area for 10 seconds.

Figure 6 : Goal-Kick

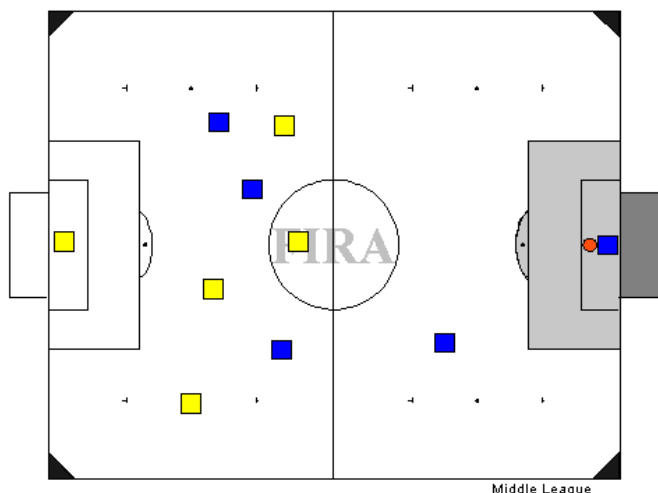

Goal-Kick situations:

- 1) Touching or directly or indirectly blocking or pushing the goalkeeper.
- 2) Attacking with more than one robot in the opposite goal area.
- 3) Attacking with more than three (Middle League) or more than four (Large League) robots in the opposite penalty area (contains goal area).
- 4) Goalkeeper catches the ball with its appendages (if any) in its own penalty area.

Robot and ball positions:

- 1) The ball can be placed anywhere in the goal area.
 - 2) Only the goalkeeper is allowed in the goal area.
- Middle League:
- 3) Defending team positions first, within their own half
 - 4) Attacking team places their robots anywhere on the field.

12.2 During goal kick only the goalkeeper will be allowed within the goal area and the ball can be placed any-where within the goal area. Other robots of the team shall be placed out-side the goal area during goal kick. The attacking team will get preference in position-ing their robots any-where on the play-ground, but it must be as per Section 8.3. The defending team can then place its robots within their own side of the play-ground. The game shall restart with the referee's whistle.

13. FREE BALL (SEE FIGURE 7)

13.1 Referee will call a free-ball when a stalemate occurs for 10 seconds outside the goal area.

13.2 When a free-ball is called within any quarter of the playground, the ball will be placed at the relevant free ball position (FB) (Figure 1). One robot per team will be placed at locations 25cm apart from the ball position in the longi-tudinal direction of the playground. Other robots (of both teams) can be placed freely outside the quarter where the free-ball is being called, but with the rule that, the defending team will get their preference in position-ing their robots. The game shall resume when the referee gives the signal and all robots may then move freely.

Figure 7 : Free-Ball

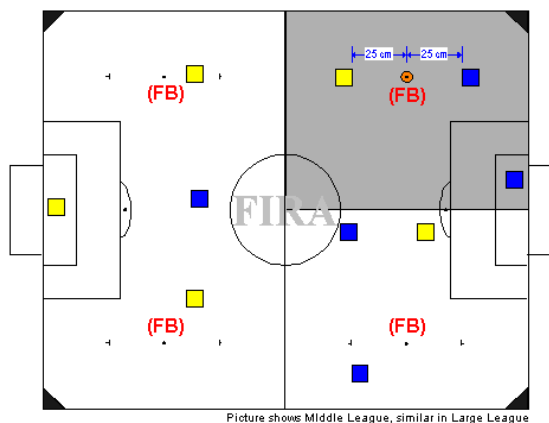

Picture shows Middle League, similar in Large League

Free-Ball situations:

- 1) Colliding with a robot of the opposite team if it affects the play (Free-Ball on the side of the offending team.)
- 2) Stalemates outside of goal area for 10 seconds with no or two or more robots of different teams involved.

Robot and ball positions:

- 1) Ball on the appropriate Free-Ball position (FB).
- 2) Robots on the appropriate Free-Ball robot positions. 25 cm (Middle League) or 30 cm (Large League) apart horizontally, defending team towards their goal.
- 3) All other robots can be placed freely outside of the Free-Ball quarter, the goalkeepers may be placed anywhere in the goalarea. The defending team will position first.

Rocky Terrain as constructed from marbles
Figure 2 (right)

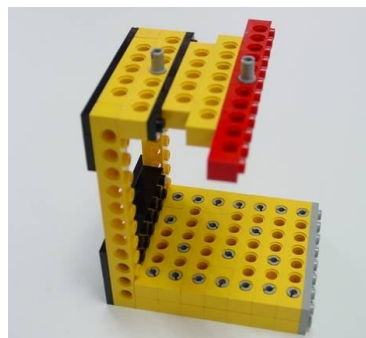

Construction of the Rocker Arm

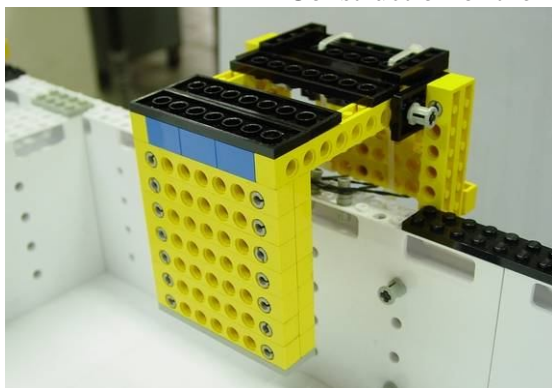

Rocker Arm Front View

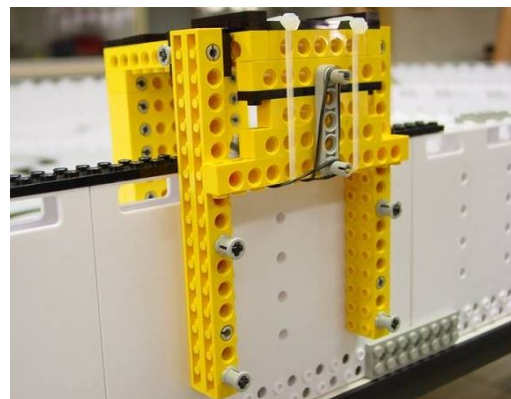

Rocker Arm Back View

Figure 3: The Rocker Arm

e) An **example** of the playing field is given in Figure 4. Other than the rocky-terrain obstacles, other types of obstacles include:

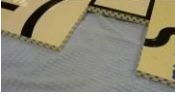
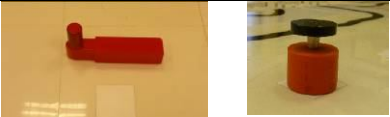
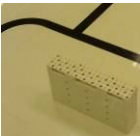
<ul style="list-style-type: none"> • Obstacles created by removing the brick tiles, 	
<ul style="list-style-type: none"> • Cylindrical obstacles to be placed randomly by the judges just before competition commences to prevent robot from taking “short cut” to reach the “can”, 	
<ul style="list-style-type: none"> • Other fixed obstacles are placed near the end of each path. 	

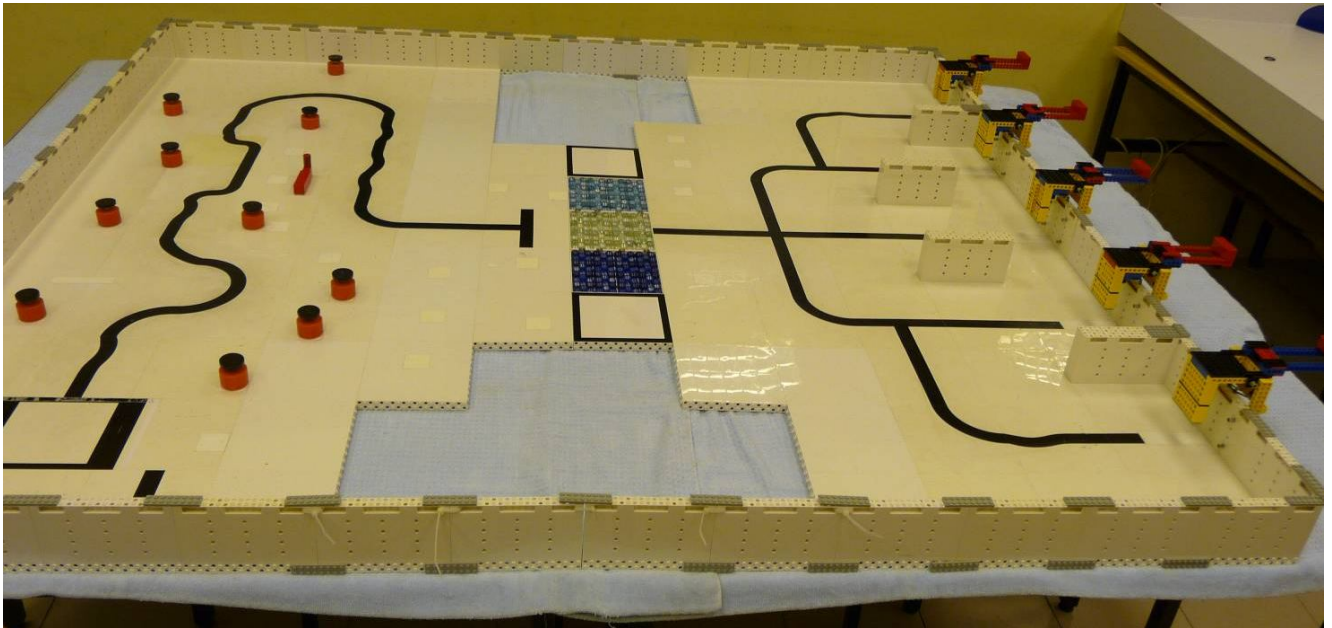

Figure 4(a): An Example of Playing Field Layout

4.3 Each team will provide a robot and a transmitting controller. The robot will be started manually at the start box of module 1 playing field. **One 200g “can” will then be placed on one of rocker when the robot reaches end of module one of the path. At the same time, the transmitting controller will transmit wirelessly the required can’s position to the robot.** The robot is to acknowledge the can’s position information by **echoing the information****. After the acknowledgement, the transmitting controller is to stop the transmission. The handler is **not allowed to handle** the transmitting controller **after it is turned on and the program running**. **A penalty of 0.5 points (2 penalties is equivalent to one can collected)** will be given if the controller does not stop transmission after the acknowledgement and when the robot collected the can and return to the starting position.

Both the robot and the transmitting controller will be caged at the beginning of the event. A printout of the transmitting program must be submitted at the time of caging. For different teams from the same school, the same transmitting controller can be used. However this must be made known at the time of caging with the team names stated in the printout.

4.4 Upon reaching the end-of-path, the robot has to collect the “can”. Robot should make contact with the rocker arm to dis-lodge the “can” onto its receptacle. Robot must then carry the “can” (off the ground), and bring it back to the starting box. The “can” is said to be **successfully delivered** when any part of the robot body touches the starting box outline. Upon reaching the finishing position, the handler will unload the “can” and at the time reposition the robot within the starting box to commence the following run to collect the next “can”. The transmitting controller could be reset if needed. Only one “can” is to be collected for each run. Only one handler is allowed to assist the robot at the starting and finishing position and another handler to operate the transmitting controller.

4.5 It is considered an “**aborted run**” should the robot drop its “can” on the field in the course of its run. The robot is to start from the starting position and a “**can**” **will be placed on any rocker arms by the judge**. **The transmitting controller is to be re-sent the can position**.

4.6 The robot is given **four minutes** to collect as many “cans” as possible. The robot must collect at least 1 can successfully to qualify for a prize.

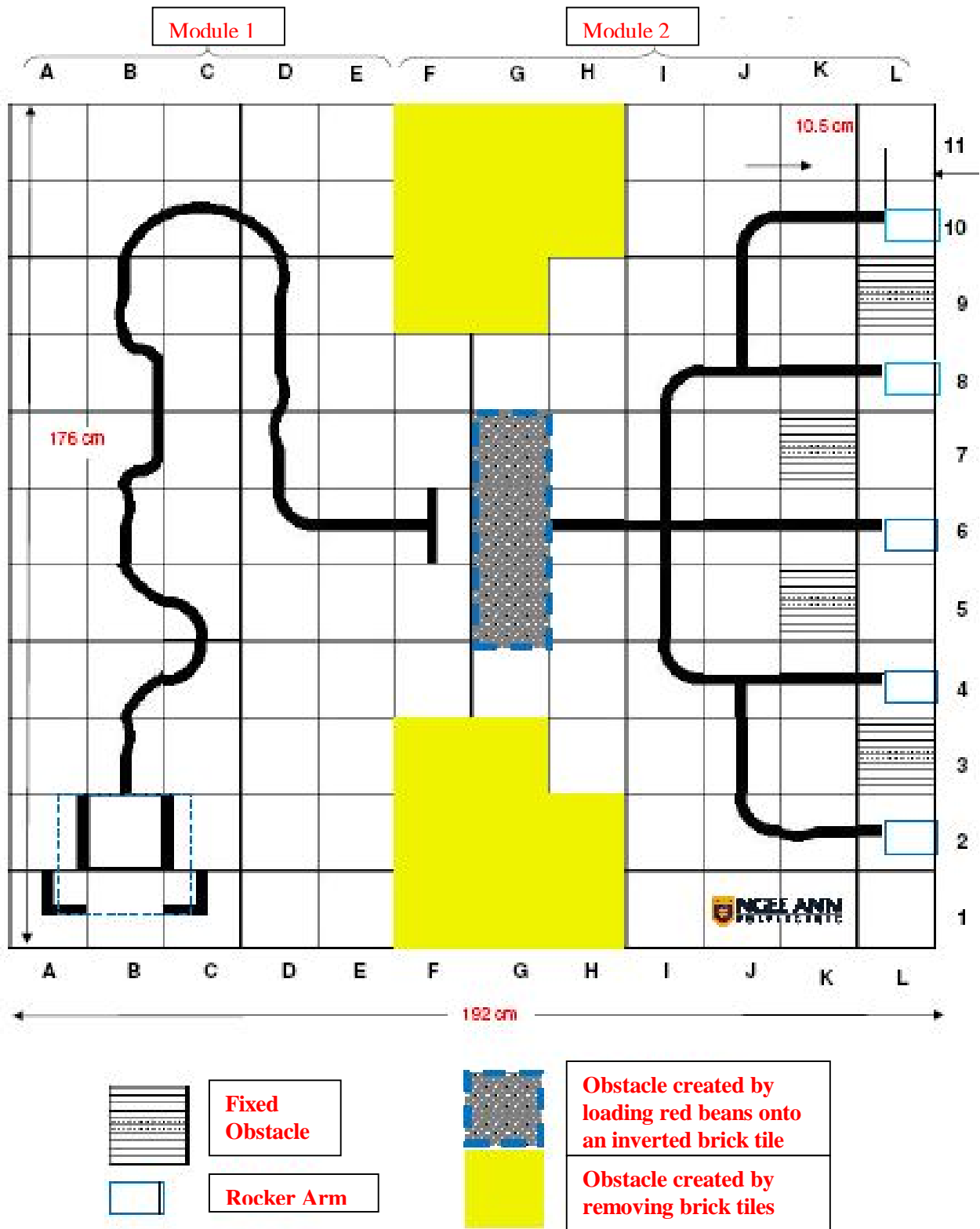

Figure 4(b): An Example of Playing Field Layout

4.7 No adjustment is allowed in the open field during the run. The robot must be brought back to the starting box and restart when being inactive, disabled, stuck or out of control in the open field. This will be considered as one aborted run, and the decision to abort the run is at the discretion of the handler.

Permission may be granted for 1 recess (10 minutes) and it carries a penalty of 2 minutes on the competition time.

- 4.8 In the event of a tie, **the robot that collects a “can” in its very first run and with the shortest time will be ranked highest.** If there is still a tie, the robot with the least number of aborted runs during the game will be ranked next. On further tie, the rank will be determined by either the shortest time for a successful collection of a “can” or the furthest distance covered for a non-delivery, of ONE final run.

FAQ (Frequently Asked Questions)

1. Must we use only Lego parts. Can we use parts from other sources?
There is no restriction on parts used.
2. How many motors are allowed?
No limits on number of motors used. However, you are limited in the use of maximum 9 V (6 x 1.5V) battery source.
3. How many sensors are allowed?
No restriction on number of sensors used.
4. Are we allowed to use other microprocessors beside the RCX and other type of sensors supplied with Lego Mindstorm?
There are no restrictions microprocessor and sensors used.
5. Can my robot collect more than one can at a time?
No, robot can only collect one can at one time.
6. What brand is the can drink?
We use Jia Jia Herbal Tea cans.
7. What is filled inside the can to make its weight 200g?
Beans or rice.
8. Will there be a practice run?
Due to constrain in the venue, we could only set up the track on the actual day. We might consider allowing practice time one to two hours before event commences.
9. Are we allowed to measure the light sensor values so that we can program it on our robot before caging?
Please do so during practice runs, usually few hours before the event.
10. What does caging mean?
Only participating robots need to be caged in a common area before the start of competition. Caged robot will only be released back to the students until the end of the whole competition.
11. Can I take back my robot if I know I have no chance of winning any medal?
Usually you are not allowed to take back your robot till the end of the competition. However, we understand that some school need to leave early as the bus is waiting etc. In that case, we allow early return of robots provided all the teams from the same school have completed their runs and are out of contention for any medals.
12. Must the entire robot start behind the starting line or can some parts of the robot be in front of the line such as the light sensor?
The entire robot including sensors, arm etc need to be behind the starting red line.
13. Must the robot follow the line strictly. Can we just program the robot to go straight without following the line.
Robot must follow the line to reach the “can” as there are obstacles placed randomly everywhere and robot will not be able to take any short-cut .
14. Is flash photography allowed during the runs?
Flash is not allowed as flash might affect the light sensors.
15. Are we allowed to wipe the playing field with a dry cloth before starting the run?
Yes, but please inform the judges first to get his/her permission.
16. What kind of message is sent by the broadcasting controller?
Participants decide their own message.

17. Which is “can” number 1 and which is “can” number 5?

“Can” number 1 is at grid I2, while “can” number 5 is at grid I10.

18. Where is the transmitting controller positioned?

The transmitting controller is to be held by a handler standing directly opposite the handler managing the robot.

19. Who will be responsible to operate the broadcasting controller? How could you ensure that message is sent at the right time?

A team member will operate the transmitting controller. The judge or the event organizer will inform the team member the “can position” after the robot start moving away from the “start” position where the handler is not allowed to touch the robot anymore.

The picture shows the transmitting controller location and the robot location when the can position is made known.

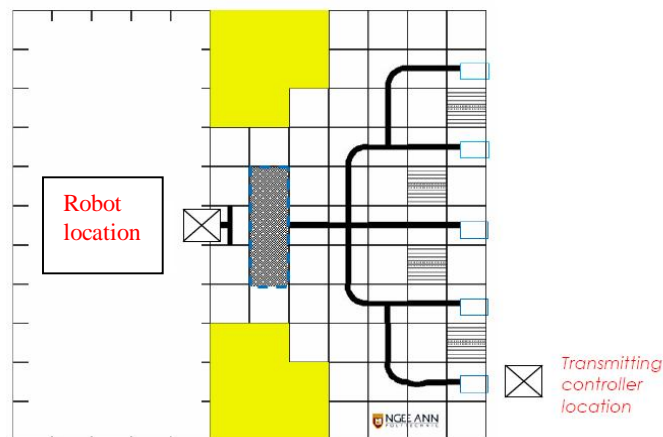

20. What is meant by “echoing the information received 3 times.” in para 4.3 line 5?

Upon receiving the can position message by transmitting controller, your robot’s controller must echo some message to acknowledge receipt of the message back to the transmitting controller. Upon the receipt of the acknowledgement the transmitting controller is to stop running the program, otherwise a penalty of 0.5 point will be given. (2 penalties equivalent to one can collected.)

UNDERWATER ROBOT COMPETITION

1. OBJECTIVE

Underwater vehicles are vital to port & harbour security, naval and scientific exploration, underwater cleaning etc. This fun-filled and challenging competition aims to introduce students to this fascinating world so that they can explore career opportunities in this field. The competition will spur interest and promote education in this area and motivate young and aspiring engineers and scientists to further pursue this field.

The competition aims at the following long term goals

- Address shortage of skilled individuals to support advanced marine engineering in Singapore
- Reach more students & get them interested in the industry. Help students develop the skills to support marine engineering early on through fun filled activities
- Complement & expand educators' knowledge and expertise in this field

2. BRIEF DESCRIPTION OF MISSION

- 2.1 The team of contestants have to design and build a remote operative vehicle (ROV) or an autonomous underwater vehicle (AUV). ROV and AUV are separate categories.
- 2.2 The mission involves the picking up of as many objects (cargoes, one at a time) from the middle section of the tank and dropping them in baskets at either ends of the tank. At the end of each run the number of objects in each basket ideally should be equal. For both ROV and AUV, each pair (one in each basket) gets four (4) points and remaining unpaired objects in the basket get one point each. For AUV's, they shall be awarded double the points for ROV's, as well as a bonus of two (2) points on condition that the robot(s) deliver(s) at least one (1) object into the basket.
- 2.3 While doing so they would have to maneuver through window frames which will be non magnetic on either sides of the tank.

3. TANK SPECIFICATIONS

- 3.1 The game will be played in an L-shaped tank of dimension: 1425mm x 1425mm x 500mm. The tank has a glass of 12.5 mm thickness. See Figure 1 for details.
- 3.2 There shall be two rectangular window frames, 30mm thickness, and one on each section of the tank 500mm from the ends of the tank. See Figure 2 for detailed dimensions.
- 3.3 The centre section of the tank will have a bump which is 12.5mm in height.
- 3.4 In the central area of the tank there shall be a cargo holder containing 16 objects arranged in a grid. This holder will be elevated from the tank floor by about 2 cm. See Figure 1 layout.
- 3.5 The cargo holder will be a square of 100mm sides with the sixteen objects arranged in a grid. The cargo holder will be made from a non-magnetic material. See Figure 3.
- 3.6 The cargo to be lifted will be marbles in the case of ROV and nuts for AUV as shown in Figure 4. The marbles are ceramic in nature and will have a diameter of around 15-17mm weighing 3 to 7g each. The nuts will be ferromagnetic and weigh between 10g to 20g.
- 3.7 A black tape, 4 to 5cm wide, will run through the centre of the tank and on both sides of the tank at a height of 20cm from the bottom.
- 3.8 There are two basket areas at both ends of the tank. There will be a barrier of about 2cm in height separating the basket from the rest of the tank.

3.9 The water depth in the tank will be 40 cm and flush with the top of the rectangular window frames mentioned in 3.2 above.

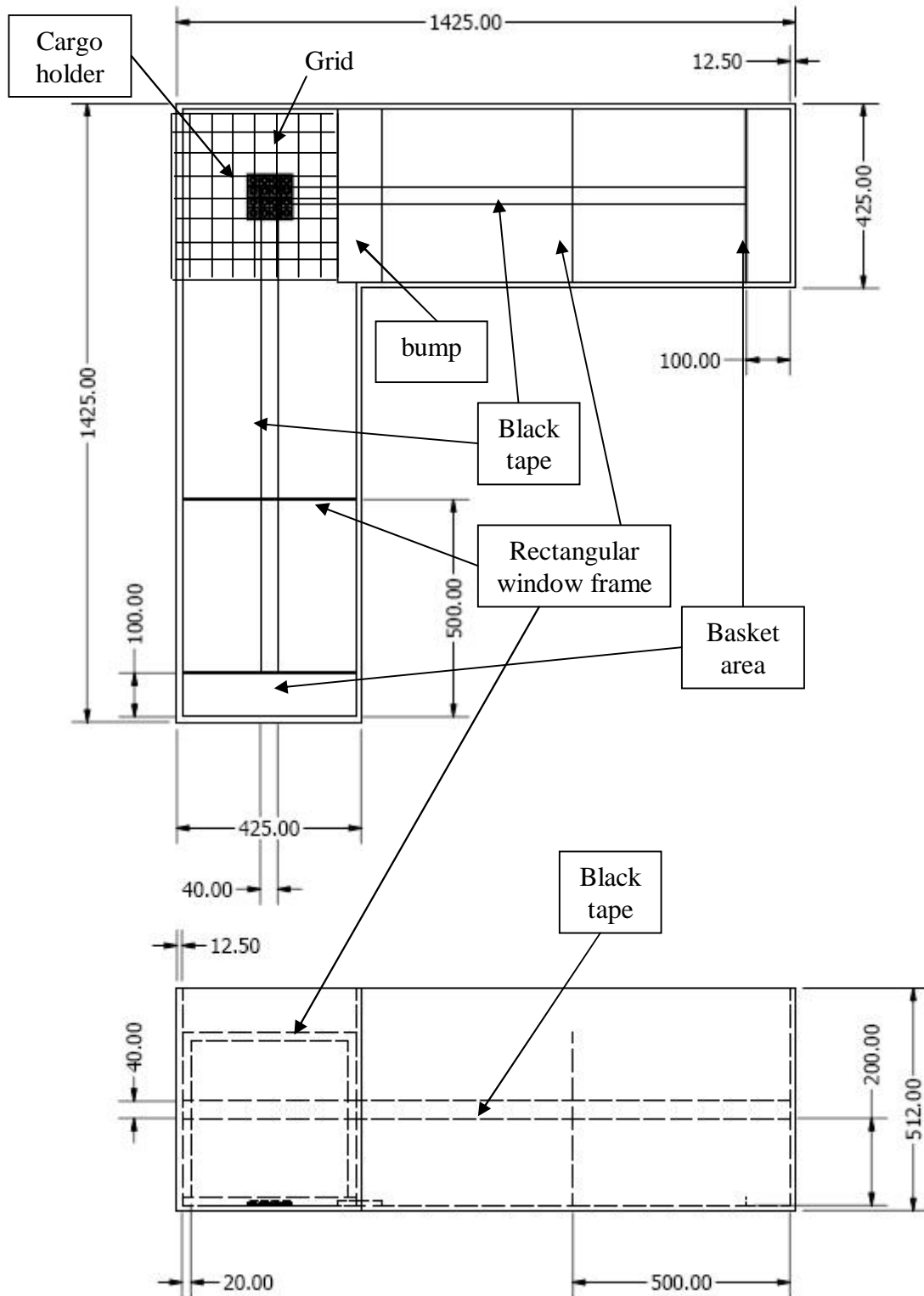

Figure 1: Tank Dimensions (in mm)

4. ROBOT SPECIFICATIONS

4.1 The robot should at the start of competition fit in a box of 30cm (width) x 30cm (length) x 30cm (height). Any vehicle found violating the dimensions shall be disqualified immediately.

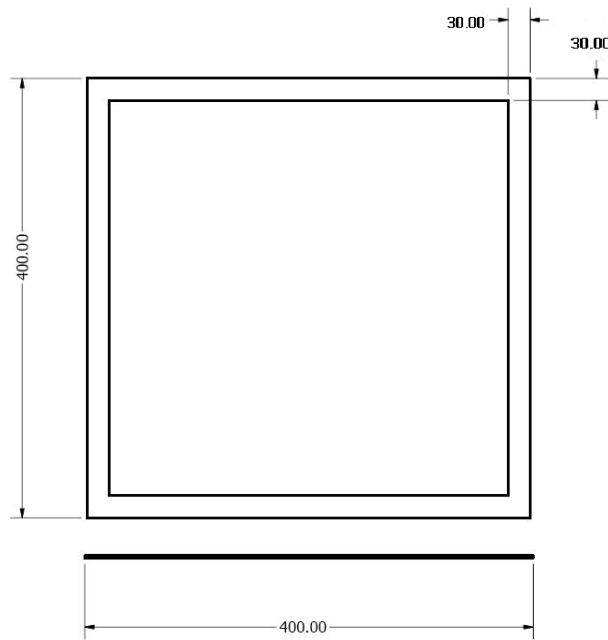

Figure 2 : Rectangular Window Dimensions (in mm)

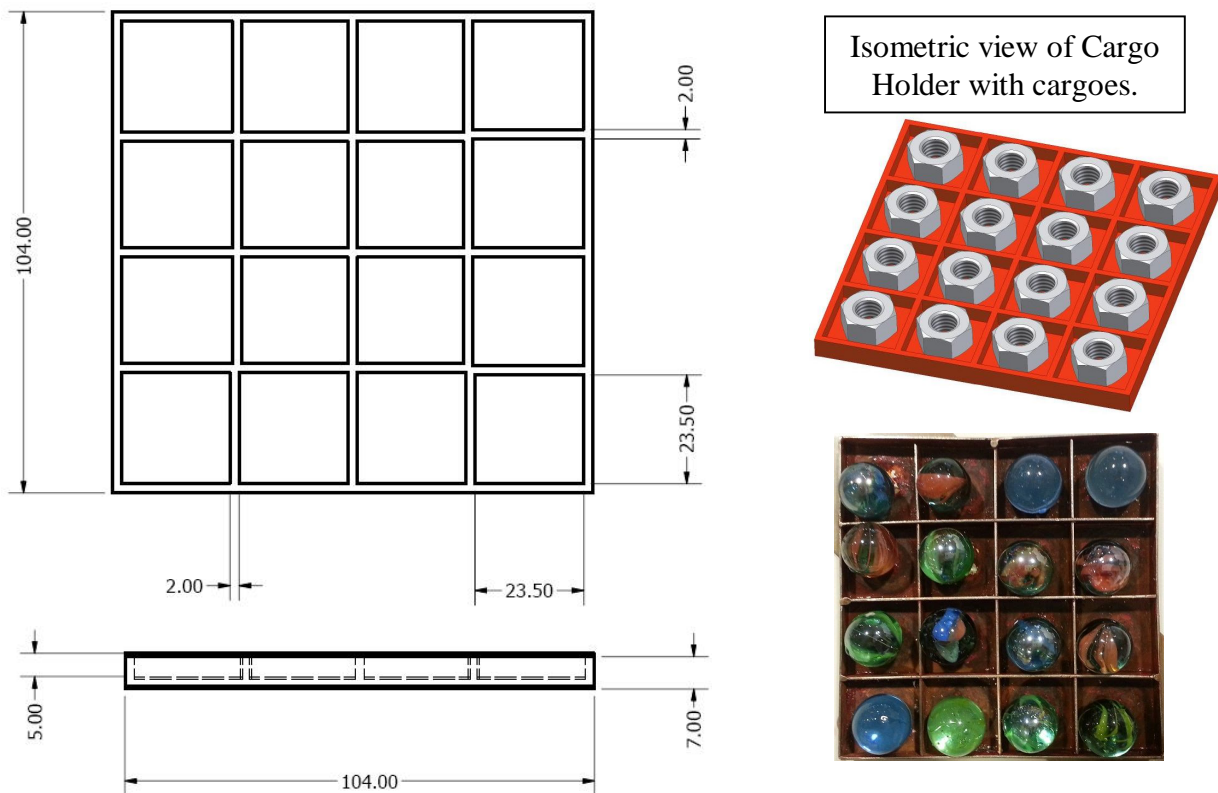

Figure 3 : Cargo Holder Dimensions (in mm)

4.2 During any attempts, the vehicle should not exceed 40cm in any one dimension. This specification however does not prevent the initial vehicle from splitting up into multiple parts as long as the above conditions are satisfied. The latter condition above would then apply to each completely disconnected part. However, at the start of the competition, the vehicle must be assembled as a single unit.

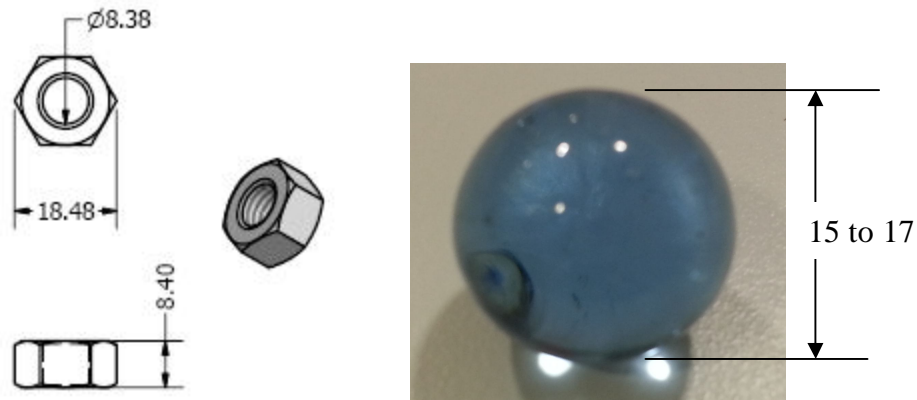

Figure 4 : Cargo Dimensions (in mm)

4.3 In case of AUV's, the method of wall sensing is at the discretion of the builder. However, the AUV must not exert a force on any wall of the tank likely to cause damage.

4.4 Wheeled or legged machines running on the tank bottom surface will not be allowed. Any other method of propulsion is at the discretion of the builder, provided that the power source is non-polluting. Use of any kind of explosive material is prohibited. Nothing may be deposited off by the machine in the tank.

5. JUDGING CRITERIA

5.1 For non-autonomous robots, points shall be awarded in the following manner:

5.1.1 4 points for each pair of objects (one in each basket.)

5.1.2 1 point for any unpaired object left in either basket.

5.2 For autonomous robots, the points scheme shall be as follows:

5.2.1 2 bonus points for autonomous vehicles if it drops at least one object.

5.2.2 8 points for each pair of objects (one in each basket.)

5.2.3 2 point for any unpaired object left in either basket.

5.3 The time for the first cargo to be dropped will also be recorded, and shall be used as a tie-breaker.

5.4 There are no penalties for hitting the tank walls or the window frame. For RC, only ONE participant is allowed to operate ONE robot. The handler / controller and robot will be paired and identified during registration and caging.

5.5 To be considered for prizes, at least one object should be dropped in either basket for autonomous robots, and two objects in each basket for RC robots.

6. RULES FOR COMPETITION

6.1 Each team will be given a competition time of 6 minutes, inclusive of setup time. Each robot is given a maximum of 3 starts within the competition time and one attempt is counted for scoring and is limited to a maximum of 4 minutes.

6.2 Robots shall start from either end of the competition tank. The starting line shall be 40 cm from either edge of the tank, and the robots may not be placed beyond this line at the start. Once team has chosen the starting end, all attempts shall proceed from the same position.

6.3 The attempt with maximum points will be considered as the team's final score. And the time recorded for the first cargo drop for the chosen attempt shall be used as tie breaker.

6.4 Any objections or appeals on discrepancies on points awarded must be raised within 5 minutes after the team completes its competition attempts and its points displayed on the official results board. Objections/appeals should be submitted in the official appeals form

available at the Reception Counter to the event chairperson. No further appeals and objections shall be entertained after the given window.

- 6.5 Judges decision is final and binding to all.
- 6.6 All robots will be caged half an hour before competition starts and would be checked for safety and cloning. Robots found to be of unsafe nature shall be disallowed.
- 6.7 The objects have to clearly fall within the basket. Objects on the basket barrier shall not be counted.
- 6.8 Any dropped object outside the cargo holder or basket will be considered out of play.
- 6.9 Each vehicle can lift only one object at a time. However while picking up objects within the cargo area, if multiple objects are picked, excess objects can be dropped back within the cargo area without penalty. In other words the vehicle should be carrying only one object once it is out of the cargo area. If multiple objects are carried at one time out of the grid area, all of them will be considered out of play.
- 6.10 Only two handlers are allowed in the competition arena for each team and only one remote controller is allowed in case of an ROV.

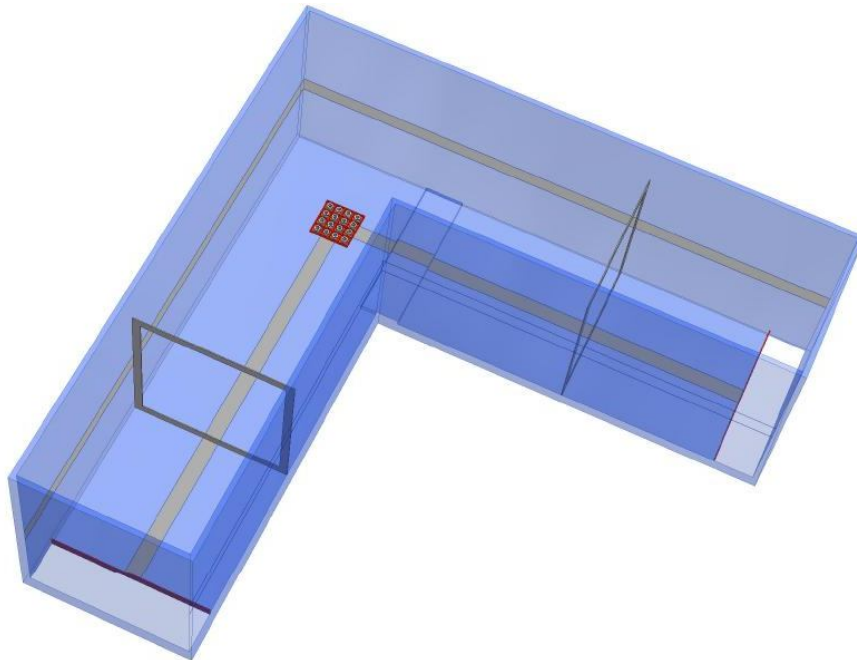

Figure 5 : Isometric view of Competition Setup

7. CLONING

- 7.1 In accordance with the spirit of the competition, clones among the winning entries will only be awarded one prize. Clones will be identified during the "caging" procedure.
- 7.2 Clones are robots with substantially identical physical appearance and working principles. This rule will be applied strictly especially for multiple entries from the same institution.
- 7.3 When in doubt, the decision of the Judges will be final. No arguments will be allowed on cloning issues once competition starts and such arguments may disqualify the team.

HUMANOID ROBOT COMPETITION

1. OBJECTIVE

The Humanoid Race is a competition between bipedal robots. The competition is to promote technology that allows robots to walk and run like human.

2. SPECIFICATIONS OF ROBOT

2.1 The robot has TWO legs ONLY. For each leg, the ONLY contacting area with the ground is the Foot. The diagram below shows the MINIMUM configuration for a lawful LEG.

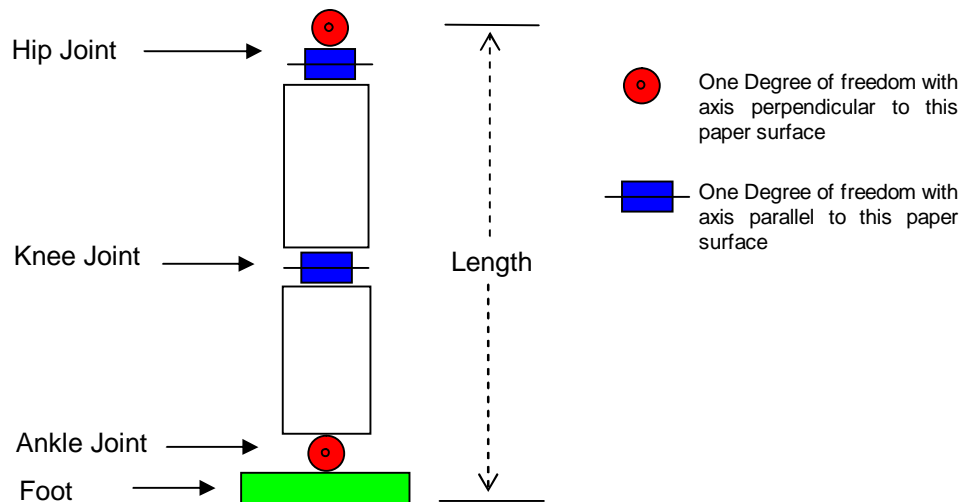

Fig. 1 – Humanoid Leg

2.1.1 Each leg should have the three joints, namely HIP joint, KNEE joint and ANKLE joint.

- HIP joint: the hip joint should have at least TWO degree of freedom as shown in the diagram above.
- KNEE joint: the knee joint should have ONLY ONE degree of freedom as shown in the diagram above.
- ANKLE joint: the ankle joint should have at least ONE degree of freedom as shown in the diagram above.

2.1.2 The **length** of leg (from HIP joint to Foot when the leg is completely extended) should not exceed 300mm.

2.1.3 The **aspect ratio** of the leg, which is defined as following

$$\text{Aspect Ratio} = \text{Length of Leg} / \text{Maximum Dimension of the Foot Surface}$$

The Aspect Ratio should be more than 1.5.

2.1.4 The maximum weight of the robot should not be more than 10kg.

2.2 The robot should be FULLY AUTONOMOUS and self-contained, i.e. there should be NO external control and power source allowed.

3. SPECIFICATIONS OF RACE TRACK

3.1 The Race Arena: [There is no predefined race arena for this game.](#) The participating robots will race using the natural floor of the competition venue. Note that since the competition venue is indoor, the floor surface can be carpet, parquet, concrete surface, etc. Participating robots are advised to be designed with tolerance with difference floor surface.

3.2 The Race Track: The Race Track shown in Fig 2 is constructed directly on the floor of the competition venue by WHITE color reflective tape of WIDTH 25mm.

- 3.2.1 All the track lines will be straight
- 3.2.2 The starting line length is 100mm
- 3.2.3 The STOP POINT and WAYPOINT1 are indicated by the BEACON that will be a standard table tennis ball of ORANGE color.
- 3.2.4 The exact location of the STOP POINT and WAYPOINT1 with respect to the center of starting line is defined by coordinate pair (X0, Y0) and (X1, Y1) respectively. The exact coordinates will be determined at the competition day. Note that X value will not be bigger than 5 meter and Y value will not be bigger than 3 meter.

Note that is reflective tape is for guiding purpose for the robot but is not mandatory for robot to follow exactly. Please refer to Section 4.3 for how the race is run.

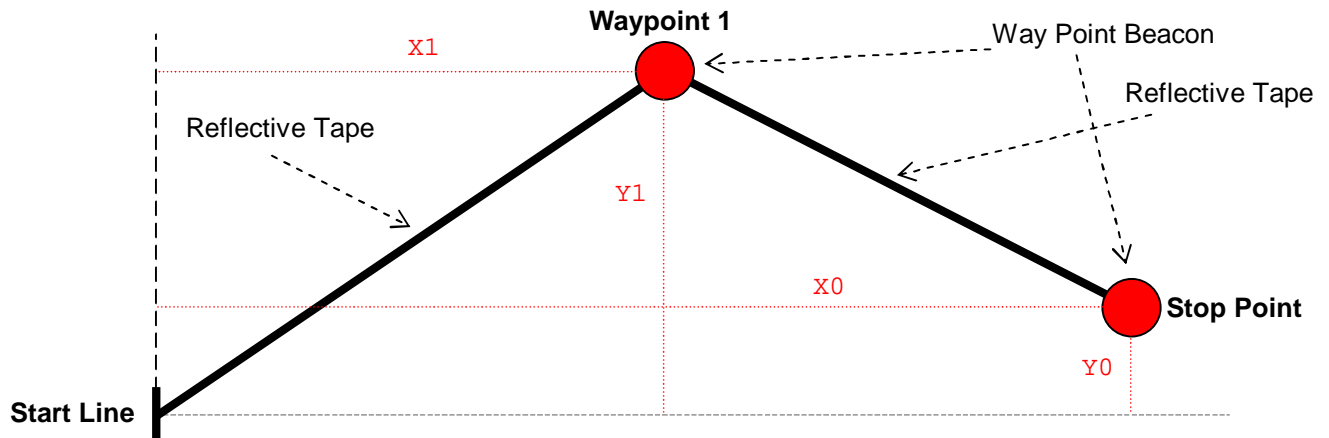

Fig. 2 - Sample Humanoid Race Track

4. RULES OF COMPETITION

- 4.1 The robot will be “caged” 30 minutes before the start of the competition. Once the competition starts, no individual is allowed to access the robots in the “caging” area. Charging of batteries is not allowed in the caging area.
- 4.2 During the caging, the humanoid robot entries will be inspected to ensure that they conform to the leg specifications. Robot handlers should demonstrate the required number of freedoms at the specified joints. Robots that are not meeting the leg specifications will be disqualified.
- 4.3 How the robot run the race
 - 4.3.1 The robot is to start from a stationary position behind the Starting Line.
 - 4.3.2 It has to reach the WAYPOINT1 and then reach the STOP POINT. The robot must touch the BEACONS at the WAYPOINT1 and STOP POINT for the race to be considered SUCCESSFUL. The robot does not necessarily follow the guiding reflective tape exactly.
 - 4.3.3 The robot can be stopped by the handler after touching the STOP POINT.
 - 4.3.4 There may be a few robots running in the same time.
- 4.4 The running time starts when the robot crosses the Start Line and ends when the robot touches/crosses the Stop Line and shall be recorded by the official timer. The robot with the shortest running time is the winner. If a robot is not able to reach the Stop Line within 10 minutes, its race shall stop and its running time shall be 10 minutes. Only robots which complete the full race course qualify for a prize.
- 4.5 In the competition, there will be preliminary round, semi-final round and final round. In each round, the robot entries will be grouped in group size of 2 or 3 to race together to run on different tracks in the same time. In each round, the running times of all robots will be

tabulated and compared for the fastest ones. The first N fastest robots will advance to the next round. The number N will be determined on the competition day based on the number of entries.

- 4.6 Between each round, the handlers of the robots are given 5 minutes to service the robot. Changing of battery is allowed. Change of robot program is strictly prohibited.

5. CLONING

- 5.1 In accordance with the spirit of the competition, clones among the winning entries will only be awarded one prize. Clones will be identified during the "caging" procedure and the handlers will be notified by the judges if their robot has been identified as a clone.
- 5.2 The decision of the Judges will be final when implementing the rules of the humanoid robot competition.

Frequently Ask Questions

Q1: What happens if the humanoid falls during the walk? Will it warrant a restart from start line or start from there with a penalty?

Ans: The race will continue without restart or penalty. If the robot is bale to recover by itself and reach the finish line, the race time is still valid. If it is not able to reach the finish line, the race time will be 10 minutes.

Q2: Will the waypoints co-ordinates be known before or after caging?

Ans: It will be made known after caging.

Q3: Can we align the robot with the reflective tape at the start point ?

Ans: Yes.

Q4: Will the background of the floor of the event location be conditioned to make the white tape easy to detect?

Ans: There will no guarantee on that.

Q5: Will the lighting condition be controlled to allow easy detection of the orange beacon?

Ans: There will no guarantee on that. The race will be based on the lighting condition of the actual competition venue.

Q6: Will reset be allowed?

Ans: No reset is allowed during the race. If the robot malfunctions, the race time will be maximum time of 10 min.

Q7: Does the robot have to follow the guide tape closely?

Ans: No, the robot does not have to follow the guide tape exactly. The race is successfully done once the robot touches all the waypoint in order.

Q8: As the robot is allowed to "fall" down and recover. Can the robot use "falling and recover" mode of moving to the waypoints?

Ans: No, the robot should not deliberately use "fall" and "recover" to complete the race. The judges will have the final decision on this matter.

Q9: Does the robot have to stop after reaching the finish line?

Ans: No, the robot does not have to stop by itself. The handler may remove the robot after it reaches the finish line.

VERSION NOTES (V22.0)

1. DESCRIPTION

This section lists the revisions made to the Rules in the current version as compared to the previous release. The list will only mention the specific sections revised and the pages the sections were located in the current rulebook, but not the detailed contents.

2. CURRENT REVISION (DATED 15 AUGUST 2014)

No.	Event Name	Section	Page	Brief Description
1	Underwater Robot Competition	2.2, 2.3 & 3.6; Fig. 3 & 4	52-54	Changed cargo specification for RC category.